

Vignatiová, Jana

[Tabulkové přehledy]

In: Vignatiová, Jana. *Břeclav-Pohansko. II, Slovanské osídlení jižního předhradí*. Vyd. 1. Brno: Masarykova univerzita, 1992, pp. 120-238

ISBN 8021004363

Stable URL (handle): <https://hdl.handle.net/11222.digilib/122577>

Access Date: 29. 11. 2024

Version: 20220831

Terms of use: Digital Library of the Faculty of Arts, Masaryk University provides access to digitized documents strictly for personal use, unless otherwise specified.

Přehled 1. POLOHA, FUNKCE, INVENTAŘ A VYOBRAZENÍ OBJEKTŮ

Čís. obj.	Umístění objektu	Osada	Funkce objektu	Počet střepů	Počet kostí	Inventární čísla	Tab.
1	L 21—75		ob. zemnice obd.	173	90	38.329—593	1
2	L 17—73		ob. zemnice čtv.	69	12	38.594—695	2
3	L 10—83		sklípek	8	5	38.896—709	3
4	L 14—73		ob. zemnice čtv.	30	27	38.710—768	3
5	L 18—74		sklípek	22	16	38.769—785	3
6	L 16—75		ob. zemnice obd.	170	170	38.786—39.117	4
7	L 17—75		sklípek	68	21	39.118—199	4
8	L 10—82		skladovací	31	—	39.200—229	5
9	L 13—75		skladovací	31	3	39.230—265	5
10	L 15—75		skladovací	180	81	39.266—525	6
11	L 37—96		ob. zemnice čtv.	71	83	126.414—570	7
12	L 34—98		ob. zemnice čtv.	20	79	126.571—669	7
13	L 37—99		ob. zemnice čtv.	74	2	126.670—752	7
14	L 34—97		ob. zemnice čtv.	67	2	126.753—855	7—10
15	L 38—96	I	ob. zemnice obd.	38	67	126.856—961	11
16	L 38—100		hrob. jáma?	24	35	126.962—127.022	11
17	L 39—97		ob. zemnice čtv.	11	13	127.023—056	11
18	L 35—99		hrob. jáma?	16	2	127.057—074	11
19	L 38—99		hrob. jáma?	11	—	127.075—083	11
20	L 34—97		hrob. jáma?	3	16	127.084—101	12
21	L 31—90		ob. zemnice čtv.	40	25	127.102—157	12
22	L 33—92		ob. zemnice čtv.	66	39	127.158—250	12
23	L 24—89		ob. zemnice čtv.	—	—	127.251—252	12
24	L 30—97	I	ohnišť	3	17	127.253—273	13
25	L 33—91		ob. zemnice čtv.	—	—	—	13
26	L 22—89		ob. zemnice čtv.	71	—	127.274—354	13
27	L 29—96		shluk nálezů	—	101	127.355—455	13
28	N 28—6		shluk nálezů	15	—	127.499—515	13
29	L 35—100		shluk nálezů	21	—	127.516—533	13
30	L 32—99		sklípek	4	5	127.534—542	14
31	N 30—7		nejasná	5	5	127.543—555	14
32	L 19—99	I	ob. zemnice obd.	107	74	127.556—718 143.477—497	14
33	N 25—6	I	ob. zemnice obd.	89	31	127.719—818 143.498—520	15
34	N 24—6	I	kamenná pec	281	175	127.819—128.040 143.521—542	16—17
35	N 25—3		ob. zemnice čtv.	117	20	128.041—168 152.309—319	18
36	N 24—3		ob. zemnice	40	6	128.169—211 143.543—546	18
37	N 26—2	I	skladovací	134	44	128.212—358	18
38	N 27—4		nejasná	—	—	143.547	18
39	N 30—5		ob. zemnice čtv.	22	4	128.359—385	19
40	L 28—100	I	kamenná pec	30	109	128.386—465 143.548—609	19
41	L 8—77		sklípek	7	9	128.466—483	19
42	L 24—82		ob. zemnice čtv.	53	—	128.484—530 143.610—616	20
43	L 20—78		ob. zemnice obd.	199	317	128.531—129.065	20
44	L 19—77		skladovací	127	198	129.066—397	20
45	L 21—78		ohnišť	13	—	129.398—410	20
46	L 37—97		shluk nálezů	33	7	129.411—440	20
47	L 37—96		ob. zemnice obd.	13	13	129.441—470 143.617	21
48	L 30—91	I	chlév	7	28	129.471—506	21
49	L 15—97		ob. zemnice čtv.	72	—	129.507—574 143.618—623	22
50	L 22—85		ob. zemnice čtv.	17	—	129.575—593	23
51	L 21—81		obilnice	30	20	129.594—644	23

Přehled 1. POLOHA, FUNKCE, INVENTÁŘ A VYOBRAZENÍ OBJEKTŮ (pokr. 1)

Čís. obj.	Umístění objektu	Osada	Funkce objektu	Počet střepů	Počet kostí	Inventární čísla	Tab.
52	L 18—79		skladovací	34	20	129.645—700	23
53	L 16—77		shluk nálezů	10	—	129.701—706	23
54	L 23—91	I	ohniště ? pec ?	1	8	129.707—715	23
55	L 23—79		nejasná	42	2	129.716—760	23
56	L 21—78		skladovací	116	155	129.761—130.033	23
57	L 28—86		ob. zemnice obd.	230	567	130.034—762	24
58	L 20—82		chlév	26	10	143.624—675	25
59	L 23—80		výrobní	136	50	130.819—911	25
60	L 24—86	I	skladovací	43	68	143.676—708	25
61	L 24—89		hrob koně	—	130	130.912—131.023	25
62	L 13—76		hrob. jáma ?	8	—	143.707—836	26
63	L 27—85		ob. zemnice čtv.	37	—	131.024—031	26
64	L 28—91		nejasná	10	7	131.032—070	26
65	L 26—86	I	chlév	23	7	131.071—089	26
66	L 16—87		hrob. jáma	4	—	131.090—111	27
67	L 14—99	I	výrobní	1.082	329	131.112—115	27
68	L 17—92	I	skladovací	246	248	131.116—132.318	27—28
69	L 16—96		ob. zemnice čtv.	82	19	143.837—144.077	29
70	L 14—97	I	špýchar	185	239	132.319—772	30
71	L 11—97		povrchové obydlí	102	42	144.078—082	31
72	L 11—91		špýchar	193	130	132.773—846	32
73	L 16—89		ob. zemnice čtv.	29	—	132.847—133.247	33
74	L 16—98		nejasná	2	22	133.248—392	34
75	N 17—2	I	skladovací	34	45	133.393—717	35
76	L 10—79		ob. zemnice čtv.	1	18	133.718—722	36
77	L 15—78		depot	33	6	133.723—747	37
78	L 31—6	I	špýchar	—	17	133.748—826	38
79	N 29—8	I	chlév	67	41	133.827—835	39
80	L 24—100	I	skladovací	11	62	133.836—866	40
81	O 67—7		fiktivní	—	—	133.887—904	41
82	N 24—3	I	skladovací	63	28	133.905—134.014	42
83	N 20—1		nejasná	9	15	134.015—087	43
84	N 22—2	I	ob. zemnice obd.	—	—	134.088—165	44
85	L 13—90		shluk nálezů	2	2	134.166—169	45
86	L 14—95		ob. zemnice obd.	80	120	134.190—195	46
87	L 12—94	I	výrobní	50	125	134.196—405	47
88	L 12—86		nejasná	66	—	134.406—572	48
89	L 9—86		skladovací	10	81	134.573—633	49
90	O 86—3		ohniště ?	17	4	134.634—726	50
91	O 85—6	II	skladovací	62	52	134.727—743	51
92	O 86—6	II	chlév	—	—	134.744—852	52
93	O 85—86		ob. zemnice čtv.	25	5	—	53
94	O 86—6	II	hrob. jáma ?	54	—	134.853—881	54
95	O 88—2		výrobní	272	223	134.882—937	55
96	O 86—4		nejasná	—	—	134.938—135.404	56
97	O 87—4		hrob. jáma ?	—	—	—	57
98	O 89—5		hrob. jáma ?	12	29	135.405—445	58
99	O 87—6		nejasná	—	—	—	59
100	O 90—4		skladovací	110	64	135.446—621	60
101	O 88—4		nejasná	21	10	135.622—646	61
102	L 2—92		výrobní ?	—	—	—	62
103	L 18—92		shluk nálezů	4	—	135.647—652	63
104	L 17—94		fiktivní	—	—	—	64
105	L 11—82		výrobní	92	89	135.653—827	65
106	L 10—84		shluk nálezů	—	8	135.828—835	66
107	L 9—84		ob. zemnice čtv.	13	—	135.836—844	67

Přehled 1. POLOHA, FUNKCE, INVENTÁŘ A VYOBRAZENÍ OBJEKTŮ (pokr. 2)

Čís. obj.	Umístění objektu	Osada	Funkce objektu	Počet střepů	Počet kostí	Inventární čísla	Tab.
108	L 9—83		fiktivní	—	—	—	42
109	L 7—88		nejasná	—	26	135.845—870	42
110	L 11—86		ob. zemnice čtv.	228	327	135.871—136.438	43—44
111	L 14—87		výrobní	16	47	136.439—496	45
112	L 7—90		výrobní	—	4	136.495—499	45
113	L 8—93		shluk nálezů	14	23	136.500—535	45
114	L 19—95	I	skladovací	59	27	136.536—614	45
115	L 19—95		ob. zemnice obd.	304	224	136.615—137.169	46
116	L 14—99	I	skladovací	34	35	137.170—238	47
117	L 14—97		nejas. kůl. jáma?	14	11	137.239—261	47
118	L 7—84		skladovací	38	11	137.262—310	47
119	L 7—87		výrobní	38	112	137.311—465	47
120	L 10—98		ob. zemnice čtv.	14	43	137.466—523	48
121	L 14—95	I	skladovací	71	119	152.340—342	48
122	L 6—88		ob. zemnice čtv.	125	92	137.524—715	48
123	L 8—84		výrobní	234	140	137.716—935	48
124	L 8—84		výrobní	42	—	137.936—138.237	49
125	L 3—92		shluk nálezů	4	—	138.238—316	49
126	L 3—92		shluk nálezů	38	5	138.317—320	49
127	C 99—92		ob. zemnice čtv.	714	283	138.321—358	50
128	C 99—91		špýchar	252	215	138.359—139.353	49
129	N 15—1	I	výrobní	199	280	139.354—808	49
130	L 12—96		povrchové obydlí	46	18	139.809—140.268	51
131	L 15—94		shluk nálezů	21	36	140.269—335	52
132	L 3—88		špýchar	31	54	140.336—387	52
133	L 4—91		fiktivní	—	—	140.388—471	52
134	L 4—88		výrobní	105	203	—	53
135	L 13—95	I	skladovací	49	67	140.472—750	53
136	L 14—100	I	skladovací	250	143	140.751—852	53
137	C 98—93		ob. zemnice obd.	22	52	140.853—141.213	53—54
138	L 1—88		shluk nálezů	—	13	141.214—280	55
139	L 1—92		výrobní	860	584	141.281—293	55
140	L 18—94		shluk nálezů	3	3	141.294—142.743	55—56
141	L 17—92		shluk nálezů	—	14	142.744—750	56
142	L 19—33	I	skladovací	195	244	142.751—765	56
143	L 13—93		shluk nálezů	4	2	142.766—143.196	57
144	L 7—93		shluk nálezů	14	22	143.197—202	58
145	L 7—98		shluk nálezů	208	11	143.203—232	58
146	C 97—94		hliněná pec	17	17	143.233—441	58
147	N 23—5	I	skladovací	146	31	143.442—476	58
148	N 23—4		ob. zemnice čtv.	73	15	152.343—427	58
149	N 26—5		shluk nálezů	24	16	152.428—500	59—60
150	N 26—3		ob. zemnice čtv.	43	24	152.501—542	60
151	N 25—2	I	skladovací	52	23	152.543—611	61
152	N 27—2		nejasná	1	10	152.612—690	60
153	N 27—2		nejasná	—	—	152.691—702	62
154	N 20—5		ob. zemnice čtv.	51	—	—	62
155	N 24—5		hrob. jáma ?	12	—	152.703—717	62
156	N 24—5		hrob. jáma ?	—	—	152.718—729	63
157	N 24—5		hrob. jáma ?	—	—	—	63
158	N 25—3	I	skladovací	75	—	—	63
159	N 25—3		hrob. jáma ?	7	8	152.730—827	63
160	N 25—4		hrob. jáma ?	—	—	152.828—842	63
161	N 20—3		hrob. jáma ?	—	—	—	63
162	N 21—2		hrob. jáma ?	—	—	152.843	63
163	N 20—3		hrob. jáma ?	—	—	—	64
164	C 82—90		ob. zemnice čtv.	76	4	152.844—888	64
165	C 95—97		skladovací	224	137	161.035—071	64
						152.889—153.265	64—65

Přehled 1. POLOHA, FUNKCE, INVENTÁŘ A VYOBRAZENÍ OBJEKTŮ (pokr. 3)

Čís. obj.	Umístění objektu	Osada	Funkce objektu	Počet střepů	Počet kostí	Inventární čísla	Tab.
166	C 96—95		ob. zemnice obd.	144	149	153.266—550	66
167	C 96—96		nejasná	8	4	153.551—562	67
168	C 97—95		nejasná	25	38	153.563—636	67
169	C 93—92		ob. zemnice obd.	22	5	153.637—664	67
170	C 90—100		výrobní	406	574	153.665—154.605	67
171	C 88—99		nejasná	—	56	154.606—661	68
172	O 91—4		ob. zemnice čtv.	38	7	154.662—699	68
173	C 93—96		skladovací	114	182	154.700—987	68
174	C 75—97		ohniště	—	—	—	69
175	C 75—97	II	kamenná pec	9	14	154.988—155.009	69
176	C 75—97	II	výrobní	81	54	155.010—150	69
177	C 75—96		ob. zemnice čtv.	270	39	155.151—451	69
178	C 73—92		skladovací	94	78	155.452—628	70
179	C 73—92		skladovací	3	7	155.629—639	70
180	C 76—91		ob. zemnice čtv.	15	16	155.640—671	70
181	C 77—99		ob. zemnice čtv.	5	5	155.672—684	70
182	C 74—97		hrob, jáma ?	6	23	155.685—716	70
183	C 72—99		ob. zemnice čtv.	88	8	155.717—814	71
184	C 72—98	II	skladovací	15	35	155.815—865	72
185	C 72—99		ob. zemnice čtv.	5	—	155.866—870	72
186	C 70—100		ob. zemnice čtv.	13	34	155.871—915	72
187	C 67—95		ob. zemnice čtv.	38	47	155.916—980	72
188	C 70—97	II	skladovací	—	—	155.981	72
189	C 68—98	II	skladovací	27	18	155.982—156.022	73
190	O 68—1	II	ob. zemnice obd.	15	22	156.023—060	73
191	O 67—7		fiktivní	—	—	—	73
192	C 68—94		ob. zemnice čtv.	—	—	—	73
193	C 83—96		výrobní	24	138	156.061—222	73
194	C 73—96	II	ohniště ? pec ?	—	—	—	74
195	C 66—94		ob. zemnice čtv.	19	2	156.223—253	74
196	C 67—96		ob. zemnice čtv.	51	76	156.254—384	75
197	C 65—96		ob. zemnice čtv.	16	40	156.385—441	75
198	C 66—94		nejasná	18	31	156.422—511	76
199	C 66—95		nejasná	10	—	156.513—520	76
200	C 86—99		nejasná	42	—	156.521—560	76
201	C 64—96	II	ohniště	6	—	156.561—566	76
202	C 64—95		ob. zemnice čtv.	26	125	156.567—720	77
203	C 66—98		ob. zemnice čtv.	78	—	156.721—734	78—79
						159.209—273	
204	C 66—99		nejasná	18	21	156.735—774	80
205	C 69—98		ob. zemnice čtv.	8	21	156.775—796	80
206	C 66—89		shluk nálezu	18	—	156.797—805	80
207	C 69—94		sklípek	—	20	156.806—826	80
208	C 64—95	II	skladovací	3	8	156.827—838	
209	O 79—9		ob. zemnice čtv.	18	7	156.839—865	81
210	C 96—88		obydlí povrchové	105	161	156.866—157.130	81
211	C 92—87		skladovací	5	62	157.131—136	82
212	C 64—100		obydlí povrchové	3	10	157.137—140	82
213	C 62—99	II	kamenná pec	37	27	157.141—183	82
214	C 59—99	II	hliněná pec	—	8	157.184	82
215	C 57—100		výrobní	10	109	157.185—198	83
216	C 55—100		skladovací	22	19	157.199—215	83
217	C 59—98	II	hliněná pec	—	—	—	83
218	C 60—97	II	hliněná pec	—	5	157.216—217	84
219	C 89—93		skladovací	192	102	157.218—406	84—85
220	C 65—100		ob. zemnice čtv.	33	8	157.407—442	87
221	C 61—99		ob. zemnice čtv.	7	21	157.443—446	87
222	C 92—89		hliněná pec	9	—	157.447—457	87
223	C 88—92		ob. zemnice obd.	13	53	157.458—467	87
224	C 87—91		ob. zemnice obd.	34	34	157.458—467	87

Přehled 1. POLOHA, FUNKCE, INVENTÁŘ A VYOBRAZENÍ OBJEKTŮ (pokr. 4)

Čís. obj.	Umístění objektu	Osada	Funkce objektu	Počet střepeů	Počet kostí	Inventární čísla	Tab.
225	C 89—92		nejasná	6	64	157.486—495	88
226	C 87—93		nejasná	—	13	157.496—497	88
227	C 88—95		skladovací	—	16	157.498	88
228	C 89—93		skladovací	23	—	157.499—521	84
229	O 72—2		ob. zemnice čtv.	14	8	157.522—536	88
230	C 86—96		skladovací	9	224	157.537—546	89
231	C 96—86		výrobní	152	281	157.547—677	89
232	L 18—100		výrobní	297	246	157.678—970	90
233	O 68—81		ob. zemnice čtv.	5	2	157.971—973	90
234	O 80—5		nejasná	13	26	157.974—987	91
235	C 75—100	II	skladovací	28	12	157.988—158.019	91
236	O 76—4		ob. zemnice čtv.	55	7	158.020—080	91
237	O 76—7	II	obydlí povrchové	16	10	158.081—098	92
238	O 74—5		shluk nálezů	6	—	158.099—104	92
239	O 75—3		ob. zemnice čtv.	52	20	158.105—140	92
240	O 62—2		hrob. jáma ?	32	1	158.141—168	92
241	C 63—100		nejasná	—	15	158.169—171	93
242	C 63—99	II	skladovací	—	3	158.267	93
243	O 79—9		sklad. ? studna ?	110	682	158.172—267	93
244	C 69—96		ob. zemnice čtv.	—	3	158.268	94
245	C 65—95		hliněná pec	3	9	158.269—272	94
246	C 63—98		ob. zemnice čtv.	—	—	—	94
247	O 66—1		ob. zemnice čtv.	22	—	158.273—293	94
248	O 64—1		fiktivní	—	—	—	95
249	C 60—99	II	hliněná pec	—	15	158.294	95
250	L 19—98		ob. zemnice čtv.	14	8	158.295—311	95
251	L 22—93		shluk nálezů	—	2	158.312	95
252	L 19—90		ob. zemnice čtv.	27	47	158.313—346	96
253	L 20—90		sklípek	8	78	158.347—357	96
254	L 13—84		hliněná pec ?	19	—	158.358—362	97
255	O 80—3		nejasná	63	19	158.363—419	97
256	O 79—6		ob. zemnice čtv.	3	14	158.420—425	97
257	C 78—85		sklípek	—	—	—	97
258	C 82—98		hliněná pec	1	3	158.426—428	98
259	C 82—99		ob. zemnice čtv.	—	—	—	98
260	O 7—68		skladovací	4	—	161.072—075	98
261	C 80—99		výrobní	27	31	158.429—456	99
262	C 80—99		výrobní	—	53	158.457	99
263	C 74—95	II	hliněná pec	6	13	158.458—464	100
264	O 63—3		nejasná	17	11	158.465—483	100
265	O 71—1		shluk nálezů	7	—	158.484—490	100
266	C 78—91		nejasná	6	—	158.491—496	100
267	C 77—83		nejasná	4	14	158.497—500	100
268	C 68—94		nejasná	6	—	158.502	100
269	C 66—97		nejasná	139	23	158.503—638	100
270	C 71—98		nejasná	10	8	158.639—650	100
271	L 14—85		sklípek	8	18	158.651—660	101
272	L 18—89		sklípek	6	6	158.661—663	101
273	L 11—95		skladovací	82	68	158.664—669 159.277—356	101—102
274	N 23—3	I	skladovací	31	25	158.670—702	103
275	L 20—91		nejasná	28	17	158.703—723	103
276	L 20—90		sklípek	26	37	158.724—747	104—105
277	C 95—90		obyt. kúl. stavba	—	—	—	105
278	C 94—87		výrobní	72	27	158.748—159.275	106
279	O 90—3		hliněná pec	3	13	158.825—829	106
280	C 89—89		skladovací	14	—	158.830—838	107
281	C 89—89		skladovací	2	—	158.839—843	107
282	C 89—89		hliněná pec	—	—	158.844—846	109
283	C 88—90		hrob. jáma ?	—	—	—	108

Přehled 1. POLOHA, FUNKCE, INVENTÁŘ A VYOBRAZENÍ OBJEKTŮ (pokr. 5)

Čís. obj.	Umístění objektu	Osada	Funkce objektu	Počet střepů	Počet kostí	Inventární čísla	Tab.
284	O 81—3		nejasná	8	4	158.847—855	108
285	O 83—1		ob. zemnice čtv.	—	—	—	108
286	O 70—8		nejasná	—	—	161.076	109
287	C 88—89		výrobní	—	—	—	109
288	O 82—7		ob. zemnice čtv.	7	13	161.077—084	110
289	O 81—8		hrob. jáma ?	16	13	161.085—098	110
290	C 88—91		hrob. jáma ?	—	—	161.099	110
291	O 77—3		ohniště ?	—	—	—	110
292	O 69—8	II	komora	98	—	161.100—190 161.922—928	111
293	O 69—5		nejasná	140	32	161.191—322	112—113
294	O 69—6		ob. zemnice čtv.	75	3	161.323—403	112—113
295	O 70—5		nejasná	228	163	161.404—611	113
296	O 70—5		nejasná	7	2	161.612—622	113
297	O 64—8		ob. zemnice čtv.	—	—	161.623	113
298	O 60—6		nejasná	11	18	161.624—635	114
299	O 56—9	III	skladovací	11	82	161.636—648	114
300	O 57—10		obyt. kúl. stavba	—	—	—	114
301	O 55—11		nejasná	—	—	—	114
302	O 55—11		nejasná	70	96	161.649—720	115
303	O 54—12	III	špýchar	103	109	161.721—807	115
304	O 52—12	III	skladovací	43	57	161.808—849	116
305	O 55—11	III	skladovací	9	8	161.850—855	116
306	O 55—8	III	skladovací	—	—	—	116
307	O 55—8	III	skladovací	8	86	161.856—865	116
308	O 53—12	III	skladovací	47	30	161.866—919	117
309	O 52—12		nejasná	1	1	161.920—921	117
310	O 64—8		komora	5	—	161.923—928	117
311	O 60—8		nejasná	5	7	161.929—934	117
312	O 57—9		nejasná	3	26	161.935—938	117
313	O 54—14		hrob. jáma ?	9	—	161.939—942	117
314	O 34—3		ob. zemnice obd.	85	132	161.943—162.026	118
315	O 33—5		hrob. jáma ?	2	—	162.027—030	118
316	O 32—5		ob. zemnice čtv.	49	—	162.031—082	118
317	O 33—7		hliněná pec	31	4	162.083—100	119
318	O 35—4		nejasná	—	—	—	119
319	O 34—4	III	sklípek	—	—	—	119
320	O 34—5		hliněná pec	11	22	162.101—114	119
321	O 35—6		nejasná	—	—	162.115	119
322	O 36—3		ob. zemnice čtv.	35	—	162.116—152	120
323	O 38—1		nejasná	—	—	—	120
324	O 38—4		nejasná	18	11	162.153—172	121
325	O 38—7	III	skladovací	11	49	162.173—185	121
326	O 38—7	III	obilnice ?	3	27	162.186—190	121
327	O 38—8	III	hliněná pec	51	36	162.191—238	121
328	O 38—8		ob. zemnice čtv.	425	226	162.239—702	122
329	O 34—9		nejasná	—	9	162.703	123
330	O 34—9		hrob. jáma ?	330	10	162.704—716	123
331	O 32—8		nejasná	8	5	162.717—721	123
332	O 32—7		hrob. jáma ?	3	3	162.722—725	123
333	O 31—6		skladovací	42	38	162.726—760	123
334	O 31—3	III	skladovací	215	57	162.761—927	124
335	O 40—4		ob. zemnice čtv.	2	2	162.928—930	124
336	O 40—5	III	hrob. jáma ?	16	10	162.931—941	124
337	O 39—4		ob. zemnice čtv.	18	5	162.946—967	124
338	O 40—5	III	ohniště	—	—	—	125
339	O 39—7		ob. zemnice čtv.	15	26	162.968—981	125
340	O 40—7		nejasná	20	4	162.982—163.003	125
341	O 40—9		nejasná	40	49	163.004—040	125
342	O 38—9		nejasná	49	86	163.041—092	125

Přehled 1. POLOHA, FUNKCE, INVENTÁŘ A VYOBRAZENÍ OBJEKTŮ (pokr. 6)

Čís. obj.	Umístění objektu	Osada	Funkce objektu	Počet stěpů	Počet kostí	Inventární čísla	Tab.
343	O 37—9		fiktivní	—	—	—	126
344	O 41—5	III	výrobní	236	199	163.093—328	126
345	O 39—6		hrob. jáma ?	10	—	163.329—333	126
346	O 44—100		sklípek	29	69	163.334—361	127
347	O 45—5	III	výrobní	287	331	163.362—608	127
348	O 46—3	III	skladovací	20	17	163.609—629	128
349	O 47—4	III	skladovací	70	59	163.630—704	128
350	O 47—5	III	skladovací	20	42	163.705—718	129
351	O 46—4	III	skladovací	44	22	164.719—750	129
352	C 45—100		skladovací	558	310	163.751—164.313	129—130
353	O 43—10	III	hliněná pec	108	32	164.315—408	131
354	O 41—11		nejasná	53	42	164.409—456	131
355	O 39—10		ob. zemnice čtv.	195	100	164.457—642	131
356	O 31—5		skladovací	22	27	164.634—666	131
357	O 31—5		hliněná pec	15	—	164.667—681	131
358	O 45—8		studna	28	55	164.682—728	132
359	O 46—4	III	skladovací	42	—	164.729—747	133
360	C 48—100	III	ob. zemnice čtv.	106	123	164.748—857	133
361	O 55—12	III	skladovací	53	5	164.858—913	134
362	O 55—12	III	skladovací	3	39	164.914—918	134
363			shluk nálezů	95	57	164.919—165.017	—
364			fiktivní	—	—	—	—
365			shluk nálezů	15	15	168.269—284	—
366			fiktivní	—	4	168.285—286	—
367	N 22—5		nejasná	4	—	168.287—290	134
368	N 21—7		fiktivní	—	—	—	134
369	N 22—6		nejasná	24	25	168.291—319	135
370	N 17—3		ob. zemnice čtv.	53	18	168.320—351	135
371	N 20—6		fiktivní	—	—	—	135
372	N 20—7		ob. zemnice čtv.	61	11	168.352—414	135
373	N 15—4		ob. zemnice čtv.	59	9	168.415—478	136
374	N 13—4		ob. zemnice čtv.	46	24	168.479—532	137
375	N 13—5		hrob. jáma ?	3	38	168.533—536	138
376	N 14—5		nejasná	9	15	168.537—546	138
377	N 11—3		skladovací	205	479	168.547—732	138
378	N 9—3		výrobní	467	469	168.733—169.110	139
379	N 7—2		skladovací	110	43	169.111—226	139
380	N 6—3		skladovací	164	100	169.227—392	138
381	N 13—1	I	obydlí povrchové	65	62	169.393—452	140
382	N 5—3		skladovací	252	259	169.453—659	140
383	N 18—6	I	ohniště ?	9	—	169.660—663	140
384	N 17—3		studna ?	4	21	169.664—670	141
385	O 96—6		ob. zemnice obd.	4	228	169.671—678	141
386	N 3—2		výrobní	39	334	169.679—723	141
387	N 3—1		hrob. jáma ?	10	—	169.724—731	142
388	N 1—2		výrobní	1.197	437	169.732—170.918	142—143
389	N 1—2		skladovací	78	126	170.919—995	144
390	O 20—6		výrobní	25	40	170.996—171.018	144
391	O 19—7		skladovací	39	64	171.019—056	144
392	O 21—7		obydlí povrchové	6	1	171.057—064	144
393	O 19—10		shluk nálezů	31	28	171.065—097	145
394	O 18—12		ob. zemnice čtv.	262	59	171.098—298	145
395	O 22—7		shluk nálezů	7	—	171.299—306	146
396	O 22—9		ohniště	—	—	—	146
397	O 23—9		fiktivní	—	—	—	146
398	O 23—11		skladovací	1	4	171.307—308	146
399	O 25—12		skladovací	—	3	171.309—310	146
400	O 27—10		obydlí povrchové	38	81	171.311—344	147
401	O 27—8		skladovací	13	105	171.345—360	147
402	O 25—5		skladovací	71	239	171.361—405	148

Přehled 1. POLOHA, FUNKCE, INVENTÁŘ A VYOBRAZENÍ OBJEKTŮ (pokr. 7)

Čís. obj.	Umístění objektu	Osada	Funkce objektu	Počet stěpů	Počet kostí	Inventární čísla	Tab.
403	○ 28—5		fiktivní	—	—	—	148
404	○ 29—5		skladovací	80	16	171.407—464	148
405	○ 30—7		nejasná	4	9	171.465—470	148
406	○ 30—8		nejasná	6	11	171.471—479	149
407	○ 35—14		skladovací	321	495	171.480—806	149—150
408	○ 38—14	III	skladovací	34	196	171.807—841	147
409	○ 38—13		ob. zemnice čtv.	12	11	171.842—855	147
410	○ 40—16	III	skladovací	156	49	171.856—172.006	151
411	○ 42—13		ob. zemnice čtv.	31	27	172.007—042	151
412	○ 43—13		ob. zemnice obd.	277	110	172.043—330	152
413	○ 47—11	III	skladovací	126	108	172.331—459	153
414	○ 27—8		ob. zemnice čtv.	—	—	—	154
415	○ 39—15		nejasná	12	13	172.463—471	154
416	○ 41—14	III	špýchar	169	435	172.472—629	153
417	○ 41—16		výrobní	198	35	172.630—829	154
418	○ 38—12		fiktivní	—	—	—	155
419	○ 39—11	III	skladovací	84	58	172.830—889	155
420	○ 43—17	III	skladovací	127	103	172.890—983	155
421	○ 28—20		povrchové obydlí	30	17	172.984—173.006	155
422	○ 32—21		nejasná	18	22	173.007—027	156
423	N 4—1		ob. zemnice čtv.	26	43	173.028—044	156
424	○ 46—10	III	skladovací	18	20	173.045—069	156
425	○ 28—6		nejasná	5	7	173.070—078	156
426	L 6—99		chlév	175	96	173.079—256	156
427	L 5—98		výrobní	252	113	173.257—510	157
428	N 4—1		hrob. jáma ?	—	—	—	157
429			nejasná	727	859	173.511—244	157
430			obyt. kúl. stavba	—	—	—	158
431	○ 41—17		obydlí povrchové	171	39	174.245—406	158
432	○ 24—7	III	skladovací	48	101	174.407—459	158
433	○ 21—8		skladovací	37	101	174.460—498	159
434	○ 21—8		skladovací	41	64	174.499—544	159
435	○ 22—8		skladovací	27	101	174.545—577	160
436	○ 27—20		ob. zemnice čtv.	—	—	—	160

Přehled 2. OBYTNÉ ČTVERCOVITÉ ZEMNICE S KAMENNOU PECÍ

Poř. čís.	Čís. obj.	Lokali- sace ve čtvercích	Plocha v m ²	Hloubka v cm	Orientace k světovým stranám	Umístění pece	Rozměry pece v cm	Rozměry topeniště v cm	Směr ústi pece	Zařízení u pece (jáma, dymník)	Tab.
1	2	L 17—73	7,2	40	rohý	V roh			k JZ	—	2
2	4	L 14—73	5,7	35	stranami	JV roh			k SZ	ve výklenku	3
3	11	L 37—96	6,4	56	rohý	J roh	65×78, v 17		k SV	—	7
4	12	L 34—98	4	30	rohý	J roh	—		k S	—	7
5	13	L 37—99	4,2	54	rohý	S roh	56×53, v 12	37×28	k JV	jáma 68×36×15	7
6	14	L 34—97	9,2	60	rohý	V roh	84×70, v 12	38×52	k J	4 kúlové jam.	7
7	17	L 39—97	7,6	59	rohý	S roh	78×77, v 16	42×22	k JV	—	11
8	21	L 31—90	6,9	58	rohý	Z roh	110×80, v 18	—	k SV	—	12
9	22	L 33—92	5	30	rohý	S roh	zbytek	—	k Z	—	12
10	23	L 24—89	8,7	77	stranami	SV roh	88×77, v 38	45×25	k V	—	12
11	25	L 33—91	5	64	rohý	S roh	55×28, v 7	55×28	k JV	—	13
12	26	L 22—89	7,8	57	stranami	SV roh	90×68, v 16	55×36	k J	—	13
13	35	N 25—3	9	68	stranami	JZ roh	105×93, v 25	63×63	k S	jáma 92×50×13	18
14	36	N 24—3	9	55	rohý	SV str. ?	zbytek	—	—	—	18
15	39	N 30—5	10	48	rohý	J roh	145×130, v 35	—	k SZ	—	19
16	42	L 24—82	8	63	rohý	V roh	95×70, v 24	—	k SZ	2 kúlové jamky	20
17	49	L 15—97	6,2	40	rohý	J roh	65×60	35×22	k SV	2 topeniště	22
18	50	L 22—85	8,8	80	stranami	JV roh	120×100, v 35	35×50	k Z	2 kúlové jamky	23
19	63	L 27—85	8	60	stranami	SV roh	110×130, v 35	—	k Z	—	26
20	69	L 16—96	7,1	68	rohý	Z roh	81×83, v 25	—	k SV	jáma 90×80	30
21	73	L 16—89	9	60	rohý	V roh	97×75, v 15	—	k JZ	—	33
22	93	O 85—86	11	75	rohý	S roh	105×100, v 30	—	k JV	—	38
23	76	L 10—79	7,5	35	rohý	S roh	zbytek	—	k JV	—	34
24	107	L 9—84	7	60	rohý	V roh	80×90, v 27	—	k JZ	1 kúl. jamka	42
25	110	L 11—86	9 ?	90	rohý	J roh	166×140, v 46	60×44	k SZ	2 kúl. jamky	43
26	120	L 10—98	9,1	53	rohý	S roh	102×45, v 22	—	k JV	—	48
27	122	L 6—88	10	82	rohý	J roh	150×70, v 20	90×50	k SZ	1 kúl. jamka	48
28	127	C 99—92	11,3	75	rohý	V roh	90×90, v 17	—	k JZ	2 kúl. jamky	50
29	148	N 23—4	11,5	75	rohý	S roh	85×90, v 53	35×55	k JV	2 kúl. jamky	59
30	150	N 26—3	7,4	80	rohý	V roh	90×80, v 35	—	k JZ	—	61
31	154	N 20—5	9,6	90	rohý	S roh	90×90, v 35	—	k JV	—	62
32	164	C 82—90	11,2	54	rohý	Z roh	70×45, v 27	47×31	k SV	—	64
33	172	O 91—4	10,8	80	rohý	V roh	95×100, v 35	—	k JZ	—	68
34	177	C 75—96	10,9	100	rohý	Z roh	porušená	—	k SV	—	69
35	180	C 76—91	10,5	78	rohý	S roh	80×70, v 32	—	k JV	—	70
36	181	C 77—99	7,6	82	rohý	S roh	zbytek	—	k JV	—	70

Prehled 2. OBYTNÉ ČTVERCOVITÉ ZEMNICE S KAMENNOU PECÍ (pokrač. 1)

Poř. čís.	Čís. obj.	Lokali- sace ve čtvercích	Plocha v m ²	Hloubka v cm	Orientace k světovým stranám	Umístění pece	Rozměry pece v cm	Rozměry topeniště v cm	Směr ústí pece	Zařízení u pece (jáma, dymník)	Tab.
37	183	C 72—99	9	82	roh	S roh	120×75, v 42	—	k JV	—	71
38	185	C 72—99	6,6	77	roh	S roh	108×112, v 47	51×32	k JV	—	72
39	186	C 70—100	11,2	78	roh	Z roh	82×94, v 22	—	k SV	—	72
40	187	C 67—95	9	105	roh	V roh	116×113, v 65	98×65	k JZ	—	72
41	192	C 68—94	9,3	72	stranami	V roh	porušená	—	—	—	73
42	195	C 66—94	7,4	69	stranami	SZ roh	90×84, v 34	58×39	k JV	—	74
43	196	C 67—96	8,8	85	roh	V roh	135×115, v 15	—	k JZ	—	75
44	197	C 65—96	13,8	82	roh	V roh	96×54, v 12	—	?	—	75
45	202	C 64—95	8,2	62	roh	V roh	120×120, v 16	—	k JZ	—	77
46	203	C 66—98	10,4	65	roh	J roh	130×100	—	k SV	—	78
47	205	C 69—98	7,3	79	roh	V roh	porušená hrobem	—	?	—	80
48	209	O 79—9	7,8	40	roh	u JV str.	120×130	—	k SZ	—	81
49	220	C 65—100	8,4	66	roh	S roh	67×40	67×40	—	—	87
50	221	C 61—99	8,6	70	roh	V roh	132×102, v 34	38×30	k JZ	—	87
51	229	O 72—2	11,9	77	roh	S roh	108×83, v 18	—	k JV	—	88
52	233	C 68—81	13,2	63	roh	V roh	120×130, v 18	—	k JZ	—	90
53	236	O 76—4	8,6	80	roh	Z roh	110×70, v 30	60×35	k SV	—	91
54	239	O 75—3	13,0	58	roh	V roh	porušená	—	?	—	92
55	244	C 69—96	9,3	114	roh	V roh	85×63, v 14	—	k Z	—	94
56	246	C 63—98	12,5	65	roh	V roh	65×90	—	k SZ	—	94
57	247	O 66—1	10,2	60	roh	V roh	p 75, v 20	—	?	—	94
58	250	L 19—98	9,9	70	roh	J roh	113×120, v 36	—	k SV	—	95
59	252	L 19—90	11,0	60	roh	S roh	75×90, v 20	—	k JV	2 kúl. jamky	96
60	256	O 79—6	10,4	80	roh	J roh	110×95, v 35	—	k SZ	—	97
61	259	C 82—99	9,3	70	roh	J roh	porušená	—	—	—	98
62	285	O 83—1	8,0	67	roh	V roh	110×110, v 30	—	—	—	108
63	288	O 82—7	10,0	72	roh	S roh	zničena	—	?	—	110
64	294	O 69—6	11,6	62	stranami	S roh	160×130, v 40	—	?	—	112
65	297	O 64—8	7,8	90	roh	V roh	70×80, v 22	—	?	—	113
66	316	O 32—5	7,7	52	roh	V roh	85×73, v 17	—	?	—	118
67	322	O 36—3	7,7	75	stranami	JV roh	95×60, v 30	—	k Z	—	120
68	328	O 38—8	9,8	30	roh	V roh	porušená	—	?	—	122
69	335	O 40—4	5,1	65	stranami	JV roh	75×50, v 10	—	k SV	—	124
70	337	O 39—4	4,7	75	stranami	JV roh	55×45, v 12	—	?	—	124
71	339	O 39—7	10,9	75	stranami	SV roh	100×100, v 12	—	?	—	125
72	355	O 39—10	6,2	60	roh	S roh	100×90	—	k JV	—	131

Přehled 2. OBYTNÉ ČTVERCOVITÉ ZEMNICE S KAMENNOU PECÍ (pokrač. 2)

Poř. čís.	Čís. obj.	Lokali- sace ve čtvercích	Plocha v m ²	Hloubka v cm	Orientace k světovým stranám	Umístění pece	Rozměry pece v cm	Rozměry topeniště v cm	Směr ústí	Zařízení u pece (jáma, dymník)	Tab.
73	370	N 17—3	5,9	60	rohy	S roh	57×32, v 23	—	?	—	135
74	372	N 20—7	6,3	119	rohy	Z roh	119×108, v 24	—	k JV	—	135
75	373	N 15—4	8,8	76	rohy	S roh	107×90, v 38	—	k JV	—	136
76	374	N 13—4	9,4	75	rohy	Z roh	100×85, v 21	60×38	k SV	5 kúl. jamek	137
77	394	O 18—12	11,4	60	rohy	S roh	porušená	50×23	?	—	145
78	409	O 38—13	5,6	55	rohy	J roh	95×95, v 20	—	k SZ	—	147
79	411	O 42—13	10,7	58	rohy	S roh	100×100, v 20	68×44	k JV	2 kúl. jamky	151
80	414	O 27—8	6,6	62	stranami	JV roh	105×95, v 12	—	?	výklenek	154
81	423	N 4/5—1	6,9	30	rohy	J roh	porušená	—	?	—	156
82	436	O 27—20	17,7	50	rohy	J roh	110×95, v 12	60×50	k SV	—	160

Přehled 3. PROTÁHLÉ OBYTNÉ ZEMNICE

Čís. obj.	Půdorysný tvar	Rozměry v cm d, š, hl	Plocha v m ²	Orience	Utváření dna	Druh otopného zařízení	Rozměry otop. zařízení	Umístění otopného zařízení	Konstrukční prvky	Tab.
1	obdélný s výklenkem	400×170×70	7,8	SZ—JV	rovné	kam. pec na soklu	100×80	S roh	zbytky dřev kameny	1
6	obdélný	575×150×60	8,6	JZ—SV	rovné, rampovitý vstup	kam. pec na soklu	80×80	V roh	—	4
15	obdéln., neúplně vykopaný	260×182×35	4,7+x	SV—JZ	rovné	ohniště obl. kameny ?	60×50	?	—	11
32	oválný	330×140×34	4,6	SZ—JV	rovné	hliněná pec	82×52	u SZ stěny	kameny v blízkosti zahloub.	14
33	obdélný	525×120×156	6,3	SV—JZ	rovné s mělkou jámou	prosté ohn. na úrovni vanovité	50×40	při stř. JV stěny	—	15
43	obdélný	370×180×135	6,6	SZ—JV	vanovité	vyvýšené vymaz. ohn. na úrovni hliněná pec	p 40	při stř. JV stěny	6 kúl. jamek při užš. st. dřevu, vchodový výklenek	20
47	obdélný s výklenkem	320×180×19	5,7	SSZ—JJV	rovné s mělkou jámou	vymaz. ohn. na úrovni hliněná pec	p 50	při stř. SV stěny	11 kúlových jamek	21
57	obdélný s výklenky	500×250×90	10,0	SZ—JV	rovné s mělkou jámou	hliněná pec	p 70	při stř. SV stěn	—	24
84	nejasný obdélný	320×190×13	6	Z—V	rovné	prosté ohn. na úrovni kameny vylož. ohniště	p 60	při V stěně	—	36
86	obdélný s vyklen. stěnami	410×230×28	6,5	SV—JZ	rovné s měl. zahloub.	hliněná pec na soklu	p 90	při SV stěně	3 kúl. jamky	37
115	oválný s výklenkem	440×180×90	7	SV—JZ	prohnuté s obv. stup.	hliněná pec na soklu	70×58	S roh	—	46
137	oválný	300×210×65	6	SV—JZ	šikmé	hlin. pec ?	p 85	poblíž SV stěny	6 kúl. jamek	55
166	obdélný	490×170×95	8,3	SV—JZ	rovné s větší jámou	hlin. pec ?	p 80 ?	při stř. JZ stěny	—	66
169	oválný	380×160×20	6	SV—JZ	vanovité	hlin. pec	p 60	u JZ stěny	—	67
190	nejasný oválný	357×195×23	6,5	SV—JZ	rovné	kameny obl. ohniště	70×50	při S stěně	—	73
223	nejasný oválný	368×170×78	6	JZ—SV	šikmé	kameny obl. ohniště	120×45	při JZ stěně	—	87
224	obdélný s výklenkem	468×150×61	7	SZ—JV	rovné s mělk. zahloubením	hlin. pec	p 70	v JV stěně	—	87

Čís. obj.	Púdorysný tvar	Rozměry v cm d, š, hl	Plocha v m ²	Orien- tace	Utváření dna	Druh otopného zařízení	Rozměry otop. zařízení	Umístění otopného zařízení	Konstrukční prvky	Tab.
314	lichoběžní- kovitý	370×210×110	7,4	SZ—JV	stupňovité	hlin. pec	p 90	v Z rohu	—	118
320	obdélný	330×180×48	5,7	S—J	rovné	hlin. pec	p 60	při J stěně	3 kúl. jamky	119
385	obdélný s výklenkem	490×170×40	8	SV—JZ	šikmé se stup- ňov. vchodem	kamenná pec	110×110	při SV stěně	—	141
412	oválný s výklenkem	460×170×52	7,8	SZ—JV	rovné	hlin. pec	72×65	při SZ stěně	—	152

Přehled 4. POVRCHOVÁ OBYDLÍ: 1. SE SNÍŽENOU PODLAHOU — 2. S KÚLOVOU KONSTRUKCÍ STĚN

Čís. obj.	Púdorysný tvar	Rozměry v cm d, š, hl	Plocha v m ²	Orien- tace	Druh otopného zařízení	Rozměry otopného zařízení	Umístění otopného zařízení	Konstrukční prvky a pozn.	Tab.
71	obdélný	480×170×20	10,8	SZ—JV	vymazané	60×50	ve středu	zahl. } tvoří zahl. } jeden objekt	32
130	oválný	285×80×20		SZ—JV	ohniště	—	—		52
210	obdélný s výklenkem	400×150×15	6	SZ—JV	hlin. pec ?	p 80	Z roh	zahloubení	81
212	oválný	286×146×24	4	SV—JZ	vymazané ohniště	p 50	při S stěně	zahloubení	82
237	oválný	300×160×40	4,8	SV—JZ	vymazané ohniště	p 55	uprostřed	zahloubení	92
277	téměř čtvercovitý	460×430	19,7	SZ—JV	hlin. pec s jámou	p 50	uprostřed	8 kúl. jamek	105
300	obdélný	420×320	13,4	ZSZ—VJV	vymaz. ohn. zahloubené	110×67	poblíž S rohu	9 kúl. jamek	114
381	oválný	270×172×30	4,5	SV—JZ	vymazané ohniště	100×60	při SV stěně	zahloubení	140
392	obdélný	390×200×20	7,8	SV—JZ	hlin. pec	135×55	při JZ stěně	zahloubení	144
400	vejčitý	400×235×35	9,0	SV—JZ	hlin. pec ?	?	poblíž SV stěny	zahloubení	147
421	obdélný s výklenkem	270×230×22	6	SZ—JV	hlin. pec	p 60	v SZ stěně	zahloubení	155
430	obdélný	460×300	13,8	JZ—SV	?	?	?	2 kúl. jamky obvod. žlábký	158
431	oválný	360×120×30	4,3	V—Z	prosté ohniště	p 50	při Z stěně	zahloubení	158

Přehled 5. HOSPODÁŘSKÁ ZAŘÍZENÍ

Druh	Čís. obj.	Půdorysný tvar	Rozměry v cm d, š, hl (p, hl)	Plocha v m ²	Orientece	Utváření dna	Konstrukční prvky a poznámky	Tab.
Komo-ry	292	čtverc. s výkl.	225×200×35	5,5	Z—V	zprohýbané	chodbov. vchod	111
	310	čtvercový	200×180×35	3,6	JZ—SV	rovné	stupeň v rohu	117
Obilnice	51	obdélný	195×70×55	1,5	SZ—JV	stupňovité	1 kúl. jamka	23
	67a	téměř kruhový	p 130, hl 90	1,1	—	zaoblené	—	27
	326	téměř kruhový	p 105, hl 65	0,8	—	zaoblené	stupeň na okr.	121
Spýchary	70	oválný	580×200×86	11,6	SZ—JV	stupňovité	vstup. schůdek	31
	72	lichoběžník.	580×480×50	16,2	S—J	vanovité	—	32
	78	obdélný	600×396×14	15	JZ—SV	rovné	1 kúl. jamka	34
	128	oválný	580×230×70	13,3	SSZ—JJV	rovné	1 kúl. jamka	49
	132	oválný	540×450×60	12	S—J	rovné	vstup. schůdek	52
	303	lichoběž. s výkl.	540×380×30	22	SZ—JV	stupňovité	—	115
	416	nepravidelný	460×380×40	17	SZ—JV	rovné s jámou	—	153
Chlévy	48	obdélný	245×105×19	2,5	SZ—JV	rovné	1 kúl. jamka	21
	58	oválný	170×90×45	1,4	V—Z	rovné	1 kúl. jamka	25
	65	oválný	180×84×40	1,5	SZ—JV	rovné	1 kúl. jamka	27
	79	lichoběž. N	220×155×18	3,3	SZ—JV	šikmé	1 kúl. jamka	36
	92	oválný	259×86×20	2,2	SZ—JV	vanovité	2 kúl. jamky	38
	426	oválný	320×190×21	5	SZ—JV	stupňovité	—	156
Skřípky	3	obdel. s výkl.	320×160×35	3,5	SZ—JV	stupňovité	—	3
	5	oválný	p 105, hl 100	3,1	SV—JZ	nerovné	1 kúl. jamka	3
	7	téměř kruhový	p 195, hl 98	3,8	—	zprohýbané	1 kúl. jamka	5
	30	oválný N	100×60×50	0,6	SV—JZ	rovné	—	14
	41	oválný N	240×185×40	4,3	SZ—JV	rovné	2 kúl. jamky	19
	207	téměř kruhový	p 195, hl 19	3,3	—	stupňovité	—	80
	253	oválný	180×140×25	2,1	SV—JZ	rovné	—	96
	257	kruhový	p 140, hl 85	—	—	stupňovité	—	97
	271	oválný	130×105×80	1,3	SSV—JJZ	stupňovité	—	101
	272	obdélný	140×95×55	1,3	ZSZ—VJV	obv. stupeň	—	101
	276	oválný	135×85×55	1,1	SV—JZ	stupňovité	3 nádoby	104
	319	oválný	135×105×26	1,3	SV—JZ	rovné	vědro	119
	346	obdélný	230×140×43	3,2	S—J	rovné	—	127

Přehled 5. HOSPODÁŘSKÁ ZAŘÍZENÍ (pokračování 1)

Druh	Čís. obj.	Púdorysný tvar	Rozměry v cm d, š, hl (p, hl)	Plocha v m ²	Orien- tace	Utváření dna	Konstrukční prvky a poznámky	Tab.
Skladovací zařízení	8	obdélný	205×81×40	1,7	SV—JZ	rovné	—	5
	9	nepravidelný	270×260×30	5,5	—	nerovné	—	5
	10	obdélný	370×105×40	3,8	SZ—JV	rovné	—	6
	37	ledvinovitý	319×182×66	5,5	SV—JZ	rovné	—	18
	44	obdélný	280×102×133	2,8	SZ—JV	rovné	stupně na okr.	20
	52	hruškovitý	180×90×30	1,6	Z—V	vanovité	—	23
	56	lichoběžník.	370×150×30	4,4	SZ—JV	klesá ke stř.	—	23
	60	oválný	255×95×40	2	SV—JZ	vanovité	—	25
	68	obdéln. s výkl.	570×180×100	8,5	SZ—JV	rovné s 2 jam.	—	29
	75	oválný	N 163×130×9	2	SZ—JV	mísovité	—	34
	80	čtver. s výkl.	N 305×235×25	4,5	SZ—JV	šikmé	—	36
	82	oválný	N 220×120×58	2,5	SZ—JV	stupňovité	—	36
	89	oválný	180×120×22	2	SZ—JV	mísovité s jámou	1 kúl. jamka	38
	91	obdélný	327×120×15	3,9	SV—JZ	prohnuté	—	38
	100	obdélný lom.	N 420×180×25	7,5	SZ—JV	šikmé se stup.	—	41
	114	ledvinovitý	340×140×15	4,7	SZ—JV	rovné	—	45
	116	vejčitý	300×170×75	4,5	Z—V	šikmé	souvisí s o. 67	47
118	oválný	290×120×24	3,4	SZ—JV	šikmé	nádoba	47	
121	lichoběž.	290×178×58	5	SZ—JV	rovné	1 kúl. jamka	48	
135	téměř čtverc.	195×190×25	3,5	SV—JZ	stupňovité	—	53	
136	hruškovitý	470×150×60	6	SV—JZ	nerovné	—	53	
142	ledvinovitý	440×190×120	8,3	SV—JZ	nerovné	—	57	
147	obdélný	420×240×40	10	S—J	zvlněné	—	58	
151	obdélný	260×92×60	2,3	SSV—JJZ	rovné s jamkou	rozl. pekáč	60	
158	oválný	N 305×165×32	5	SV—JZ	rovné	ve stř. jáma	63	
165	oválný	445×183×65	8	SV—JZ	stupňovité	—	64	
173	vejčitý	400×190×120	6	SZ—JV	stupňovité	—	68	
178	vejčitý	225×120×36	2,4	SZ—JV	mísovité	kameny ve výpl.	70	
179	obdélný	N 160×107×11	1,6	Z—V	rovné	—	70	
184	obdélný	N 212×114×43	2,4	SV—JZ	rovné se žlab.	—	72	
188	lichoběž.	242×196×70	4,5	SV—JZ	rovné s jámou	—	72	
189	obdélný	N 209×170×37	3,5	SV—JZ	rovné	—	73	
208	vejčitý	520×200×58	8	SV—JZ	nerovné	řeže obj. 202	77	
211	obdélný	310×140×87	4,3	SZ—JV	rovné	—	82	
216	vejčitý	N 350×230×48	6	V—Z	stupňovité	s kameny	83	
219	neprav. s výkl.	610×203×46	10	SZ—JV	zvlněné	splývá s o. 228	84	

Přehled 5. HOSPODÁŘSKÁ ZAŘÍZENÍ (pokračování 2)

Druh	Čís. obj.	Půdorysný tvar	Rozměry v cm d, š, hl (p, hl)	Plocha v m ²	Oriente	Utváření dna	Konstrukční prvky a poznámky	Tab.
Skladovací zařízení	227	obdélný	N 291×132×20	3,7	SV—JZ	zvlněné	—	88
	230	obdélný	N 350×220×21	7,7	SSZ—JJV	rovné s jámou	—	89
	235	pětiúhel.	N 410×230×24	8	SV—JZ	zvlněné	—	91
	242	oválný	320×90×46	2,8	Z—V	vanovité	—	93
	243	čtvercovitý	170×170×165	2,8	SV—JZ	nerovné	4 psí kostry	93
	260	obdélný	170×130×20	2,2	Z—V	vanovité	—	98
	273	obdélný	215×85×30	1,8	JZ—SV	vanovité	—	101
	274	oválný	230×120×30	2,3	SV—JZ	rovné	2 nádoby	103
	280	obdélný	146×60×35	0,9	SZ—JV	rovné	radlice	107
	281	obdélný	310×120×26	3,7	Z—V	rovné	krojídlo	107
	299	lichoběžník.	420×190×20	8	Z—V	rovné	—	114
	304	obdélný	490×155×38	6,6	S—J	rovné	—	116
	305	kosodélný	250×190×15	4,6	Z—V	rovné	porušen hr. 170	116
	306	oválný	290×125×50	3,4	Z—V	rovné	s kameny	116
	307	obdélný	280×200×55	5,6	ZJZ—VSV	s 3 zahloub.	—	116
	308	obdélný	250×120×32	3	S—J	rovné se stup.	kameny + zl. žern.	117
	325	obdélný	260×140×80	3,6	SSZ—JJV	stupňovité	—	121
	333	oválný	320×115×35	3,5	V—Z	se stupněm	nádoba, zl. kosa	123
	334	hruškovitý	300×210×35	5	SV—JZ	nerovné	—	124
	348	obdélný	220×110×12	2,4	Z—V	stupňovité	—	128
	349	obdélný	266×220×130	5,7	Z—V	nerovné	kameny v zásypu	128
	350	obdélný	275×125×85	3,2	SSV—JJZ	stupňovité	nádoba + kameny	129
	352	oválný	380×210×120	7,2	Z—V	rovné	destr. vrstva	129
	356	oválný	177×140×42	2,4	SZ—JV	stupňovité	část kostry kozy	131
	359	obdélný	200×170×30	3,4	S—J	vanovité	nádoba	133
	361	oválný	180×110×30	1,8	SSV—JJZ	rovné	—	134
	362	oválný	335×185×20	6	Z—V	nerovné	—	134
	377	hrušk. s výkl.	470×250×135	8,7	SZ—JV	vanovité	2 kúl. jamky	138
	379	obdélný	300×122×22	3	SV—JZ	rovné	—	139
	380	oválný	400×120×80	4,1	SZ—JV	nerovné	—	138
	382	obdélný	400×300×100	15	SSV—JJZ	stupňovité	chodb. vstup	140
	389	oválný	360×145×42	5	SV—JZ	rovné s jámou	—	144
	391	oválný	365×230×65	8	SZ—JV	rovné	—	144
	398	oválný	320×200×25	6	S—J	šikmé	žernov	146
	399	obdélný	350×140×17	4,9	SZ—JV	rovné	žernov	146
	401	obdélný	470×200×40	9	S—J	vanovité	—	147

Přehled 5. HOSPODÁŘSKÁ ZAŘÍZENÍ (pokračování 3)

Druh	Čís. obj.	Půdorysný tvar	Rozměry v cm d, š, hl (p, hl)	Plocha v m ²	Orien- tace	Utváření dna	Konstrukční prvky a poznámky	Tab.
	402	nepřavidelný	390×220×45	6,5	SV—JZ	stupňovité	—	148
	404	oválný	340×255×35	8,5	SZ—JV	šikmé	žernov	148
	407	hruškovitý	500×220×72	7,5	ZSZ—VJV	stupňovité	—	149
	408	oválný	200×155×23	2,8	SZ—JV	rovné	—	147
	410	oválný s výkl.	190×115×28	1,9	SZ—JV	šikmé	—	151
	413	oválný	436×135×53	5,5	SV—JZ	stupňovité	—	153
	419	obdélný	260×175×50	4,4	SSV—JJZ	rovné	—	155
	420	nepřavidelný	310×190×45	4,6	Z—V	nerovné	zlomky pekáče	155
	424	obdélný	N 130×80×35	1	SV—JZ	rovné	—	156
	432	vejčitý	320×160×60	3,3	SZ—JV	vanovité	—	158
	433	oválný	295×165×68	4,4	Z—V	rovné	—	159
	434	obdélný	N 350×250×47	8,7	Z—V	rovné s jámou	—	159
	435	vejčitý	500×230×40	9	SZ—JV	stupňovité	—	160

* N uvedené u půdorysného tvaru znamená, že obrysy zásypu byly na začištěném podloží nejasné; zásyp byl vybrán jen přibližně podle zbarvení a výskytu náleží do konečného tvaru (obdélník, ovál apod.)

** Uváděny jsou jen maximální rozměry, tedy nikoliv rozměry zúžených částí, výklenků apod.

Přehled 6. DÍLENSKÁ ZAŘÍZENÍ

Čís. obj.	Půdorysný tvar	Utváření dna	Rozměry v cm d, š, hl *	Orien- tace	Stopy ve výplni	Kúlové jamky	Otopná zařízení	Interpretační poznámky	Tab.
59	čočkovitý	stupňovité	520, 220, 30	SZ—JV	kameny, výmaz	—	kamen pec ?	hrnčičské	25
67	oválný s vý- klenkem	zprohýbané	650, 300, 75	SZ—JV	kameny, výmazy	2	1 hliněná * 2 kam. pece	hrnčičské	27
87	obdélný	rovné	320, 176, 30	SV—JZ	kam. zával, dřevo	—	—	koželužské ? sušárna ?	37
95	vejčitý	šikmé	341, 220, 130	SZ—JV	kamenný zával	—	2 kamenné pece	udírna	40
102	hruškovitý	stupňovité	235, 165, 105	SZ—JV	výmaz dna pece	2	hliněná pec	—	41
105	obdélný	rovné	415, 150, 70	SV—JZ	kam. zával, dřevo	1	hliněná pec	koželužské ? sušárna ?	42
111	obdélný	rovné	260, 155, 30	SV—JZ	kamenná kra	—	kamenná pec?	—	45
112	ledvinovitý	rovné	290, 145, 70	V—Z	kam. zával, dřevo	4	—	koželužské ? sušárna ?	45
119	obdélný	šikmé s já- mou	360, 220, 93	SV—JZ	kamenný zával	—	—	koželužské ? sušárna ?	47
123—4	vejčitý	stupňovité s jámou	390, 210, 70	S—J	kameny, žer- novy, výmaz	11	2 hliněné pece	pekárna	49
129	nepravidelný s výklenky	rovné s 2 jámami	960, 400, 60	SZ—JV	skupiny kamenů	5	—	košíkařské	51
134	obdélný	stupňovité	340, 215, 93	SZ—JV	kameny dřevo	3	ohniště vylo- žené kameny	koželužské ? sušárna ?	53
139	nepravidelný s výklenky	nerovné	440, 235, 112	SV—JZ	kameny, mazanice	—	kam. pec s hlin. topen.	řezbářské ?	55
170	obdélný s vý- klenkem	stupňovité	420, 140, 90	SZ—JV	kameny, mazanice	—	hliněná pec?	—	67
176	kosodélní- kovitý	šikmé s já- mou	245, 115, 85	SV—JZ	kameny	—	ohniště ?	kostařské	69
193	vejčitý	stupňovité, šikmé	405, 150, 61	SZ—JV	kamenný zával	—	kamenná pec?	výheň ?	73
215	obdélný	rovné	383, 155, 58	SV—JZ	kam. zával, dřevo	—	—	koželužské ? sušárna ?	83
231	obdélný	šikmé	345, 125, 90	SZ—JV	—	2	hliněná pec	kostařské	89

Přehled 6. DÍLENSKÁ ZAŘÍZENÍ (pokračování 1)

Čís. obj.	Půdorysný tvar	Utváření dna	Rozměry v cm d, š, hl *	Orien- tace	Stopy ve výplni	Kulové jamky	Otopná zařízení	Interpretační poznámky	Tab.
232	obdélný s vý- klenkem	rovné se 2 jámami	280, 140, 40	SZ—JV	ořezané rohy	1 ?	—	kosfařské	90
261—2	nepravidelný s výklenky	nerovné s jámami	870, 430, 50	SZ—JV	2 výmazy, 2 skup. kamenů	—	2 hlin. pece kam. ohniště	—	99
278	obdélný	nerovné	420, 320, 72	SZ—JV	3 výmazy	2	3 hliněné pece	pekárna	106
287	obdélný s vý- klenkem	stupňovité s jámou	330, 160, 75	Z—V	výmaz dna pece	—	hliněná pec	—	109
344	obdélný	šikmé	485, 230, 40	SZ—JV	—	—	—	košíkářské	126
347	hruškovitý	vanovité	480, 195, 160	V—Z	skupina kamenů	—	—	—	127
378	obdélný	rovné s já- mou	432, 253, 73	SV—JZ	výmaz pece závaží	—	hliněná pec	—	139
386	čtvercovitý s výklenkem	stupňovité šikmé	350, 290, 40	SV—JZ	—	—	—	textilní	141
388	nepravidelný s výklenky	nerovné	340, 370, 60	SZ—JV	4 výmazy, skup. kamenů	—	ohniště + 4 hliněné pece	pekárna	142
390	ledvinovitý	rovné	315, 200, 40	SV—JZ	výmaz, dřevo kameny	—	kamenná pec	hrnčířské	144
417	nepravidelný s výklenkem	nerovné	550, 250, 48	S—J	výmaz dna pece	—	hliněná pec	—	154
427	oválný	vanovité	412, 205, 54	SZ—JV	kamenný zával	—	kameny vylož- né ohniště	výheň	157

* Uváděny jsou jen maximální rozměry; hloubka je měřena od úrovně podloží; jde tedy o hloubku zkoumanou, nikoliv skutečnou — původní, která byla průměrně asi o 40 cm větší.

Přehled 7. SAMOSTATNĚ STOJÍCÍ OTOPNÁ ZARÍZENÍ

Čís. obj.	Půdorysný tvar zhloubení	Rozměry zhloubení v cm d, š, hl	Plocha v m ²	Orientace	Zbytky otopného zařízení	Rozměry otopného zařízení	Druh otopného zařízení	Tab.
24	oválný	208×115×38	2,3	SV—JZ	kra mazanice	37×22	vymaz. a vyvýš. ohn. (?) s jámou	13
45	nejasný obdélný	225×130×15	2,9	SZ—JV	kra mazanice	40×30	vymazané ohn. (?) na úrovni	20
54	—	—	—	—	vrstva valounků s výmazem	80×60	vymaz. ohn. (?) dno pece (?)	23
90	—	—	—	—	kra mazanice	p 55	vymaz. ohniště na úrovni	38
146	oválný	130×90×56	1,2	JZ—SV	vrstva mazanice	50×40	dno hliněné pece	58
194	—	—	—	—	drobné kameny s výmazem	65×50	vymaz. ohn. ? dno pece (?)	74
201	—	—	—	—	výmaz	p 40	vymaz. ohniště na úrovni	76
214	—	—	—	—	obvodové stěny pece	64×58	hliněná pec	82
217	oválný	65×47×15	0,3	SZ—JV	obvodové stěny pece	p 63	hliněná pec	83
218	oválný	265×140×50	3,5	Z—V	obvodové stěny pece	p 45	hliněná pec	84
222	oválný	273×80×35	2,1	SZ—JV	vymazané dno pece	130×60	hliněná pec	87
245	nejasný oválný	180×132×29	2,3	S—J	vymazané dno pece	75×35	hliněná pec	94
249	nejasný oválný	200×140×28	2,7	S—J	obvod. stěny a dno pece	80×75	hliněná pec	95
254	obdélný	205×110×22	2,2	SZ—JV	roztažené kusy mazanice	?	zničená hliněná pec ?	97
258	hruškovitý	330×160×155		SV—JZ	obvodové stěny pece	85×80	hliněná pec	98
263	obdélný	210×70×35	1,5	JZ—SV	obvod. stěny a dno pece	70×55	hliněná pec	100
279	oválný	310×80×40	2,3	SZ—JV	obvod. stěny a dno pece	p 55	hliněná pec	106
282	obdélný	190×100×32	1,9	JZ—SV	obvod. stěny a dno pece	80×65	hliněná pec	109

Přehled 7. SAMOSTATNĚ STOJÍCÍ OTOPNÁ ZAŘÍZENÍ (pokračování 1)

Čís. obj.	Půdorysný tvar zahroubení	Rozměry zahroubení v cm d, š, hl	Plocha v m ²	Oriente	Zbytky otopného zařízení	Rozměry otopného zařízení	Druh otopného zařízení	Tab.
291	obdélný	165×110×18	1,8	SZ—JV	vymazané dno a kameny	p 50	ohniště oblož. kameny ?	110
317	oválný	285×95×22	2,7	SV—JZ	obvod. stěny a dno pece	90×65	hliněná pec	119
327	obdélný	200×130×75	2,5	Z—V	část obvod. stěn pece	p 120	hliněná pec	121
338	obdélný	210×86×30	1,8	S—J	výmaz dna	42×28	vymaz. a vyvýš. ohniště	125
353	oválný	215×165×70	2,5	S—J	obvod. stěny a dno pece	p 100	hliněná pec	131
357	—	—	—	—	obvodové stěny pece	85×60	hliněná pec	131
383	—	—	—	—	kra mazanice	80×50	vymaz a vyvýš. ohniště ?	140
396	oválný	220×125×40	2,7	S—J	část obvod. stěn pece	p 60	hliněná pec	146
34	nejasný nepravidelný	700×350×60	?	Z—V	kamenná destrukce	140×80	kamenná pec ?	16
40	nejasný nepravidelný	350×250×43	8,7	JZ—SV	kamenná destrukce	160×95	kamenná pec	19
174	oválný	120×55×20	0,6	JZ—SV	kameny v úzké jámě	74×40	zahl. kameny vyložené ohniště	69
175	nejasný oválný	165×150×40	2,3	JZ—SV	kamenná destrukce	60×40	kamenná pec	69
213	nejasný obdélný	270×160×47	4,3	S—J	kam. destr. * maz. topen.	65×58	kamenná pec	82

Přehled 8. ŽERNOVY

Poř. čís.	Čís. obj.	Invent. číslo	Zachovalost	Prům. v mm	Materiál	Poznámky o žernovu	Nálezové okolnosti
1	2	38.691	celý	460		—	ve výplni obj.
2	2	38.692	celý	470		—	ve výplni obj.
3	2	38.693	?	?		—	ve výplni obj.
4	2	38.694	celý	500		—	ve výplni obj.
5	2	38.698	zlomek	500	slepenec	—	ve výplni obj.
6	2	38.690	zlomek	—	svor	—	ve výplni obj.
7	17	127.056	zlomek	—	svor	—	součást pece
8	21	?	zlomek	—	svor	—	součást pece
9	23	127.251	24 zl.	—	svor	—	součást pece
10	26	127.352	18 zl.	—	svor	—	součást pece
11	34	128.039	celý	460	ryolit	otvor 60 mm stopy papřice	nad výplni obj.
12	35	152.319	zlomek	—	—	—	ve výplni obj.
13	42	128.530	4 zl.	—	svor	—	součást pece
14	49	129.574	14 zl.	—	—	—	součást pece
15	69	132.843	20 zl.	—	svor	—	součást pece
16	110	136.438	3 zl.	—	svor	—	součást pece
17	115	137.166	2 zl.	—	—	—	ve výplni obj.
18	120	152.342	5 zl.	—	—	—	ve výplni obj.
19	123	138.236	celý	440	ryolit	ležák, otv. 40 mm	} tvoří celý mlýnek
20	123	138.236	celý	450	ryolit	běhoun, stopy papřice	
21	123	138.235	3 zl.	—	—	—	ve výplni obj.
22	128	139.808	2 celé	?	svor	rozlámané	celý mlýnek
23	148	—	zlomek	—	ryolit	—	součást pece
24	154	152.717	zlomek	—	svor	—	součást pece
25	154	152.717	celý	480	svor	běhoun, čtyř- boký otvor 70×70 mm	součást pece
26	154	152.717	zlomek	460	ryolit	otvor 60 mm, stopy papřice	součást pece
27	164	152.888	4 zl.	—	—	—	součást pece
28	166	153.550	3 zl.	—	svor	—	ve výplni obj.
29	173	154.985	zlomek	—	svor	—	ve výplni obj.
30	178	155.628	zlomek	—	svor	—	ve výplni obj.
31	179	155.639	zlomek	—	svor	—	ve výplni obj.
32	180	155.671	9 zl.	—	—	—	součást pece
33	183	155.813	3 zl.	—	ryolit	—	součást pece
34	186	155.915	3 zl.	—	—	—	součást pece
35	195	156.252	9 zl.	—	—	—	součást pece
36	196	156.384	zlomek	—	svor	—	součást pece
37	202	156.719	12 zl.	—	—	—	součást pece
38	203	156.734	6 zl.	—	—	—	součást pece
39	205	156.796	4 zl.	—	—	—	součást pece
40	235	158.019	zlomek	—	svor	—	ve výplni obj.
41	236	158.078	zlomek	—	—	—	součást pece
42	250	158.311	2 zl.	—	—	—	součást pece
43	252	158.345	7 zl.	—	—	—	součást pece
44	256	158.425	zlomek	—	—	—	součást pece
45	292	161.189	celý	450	svor	ležák, otv. 35 mm	} tvoří celý mlýnek
46	292	161.189	celý	450	svor	běhoun, otv. 60×80 mm, st. papřice	
47	292	161.190	5 zl.	—	—	—	na podlaze obj.
48	294	161.403	2 zl.	—	svor	—	na podlaze obj.
49	297	161.623	zlomek	430	ryolit	ležák, otv. 35 mm	ve výplni obj.

Přehled 8. ŽERNOVY (pokračování 1)

Poř. čís.	Čís. obj.	Invent. číslo	Zachovalost	Prům. v mm	Materiál	Poznámky o žernovu	Nálezové okolnosti
50	297	161.623	zlomek	430	svor	ležák, otv. 32 mm	ve výplni obj.
51	310	161.928	zlomek	470	svor	ležák, otv. 35 mm	na podlaze obj.
52	347	163.608	zlomek	—	—	—	ve výplni obj.
53	358	164.726	zlomek	—	—	—	ve studni
54	374	168.532	6 zl.	—	—	—	součást pece
55	398	neinv.	zlomek	—	—	—	na podlaze obj.
56	399	neinv.	zlomek	—	ryolit	—	—
57	404	neinv.	celý	470	svor	běhoun, otv. 85 mm čtyřb.	na podlaze obj.
58	409	neinv.	zlomek	—	—	—	součást pece
59	411	neinv.	zlomek	—	ryolit	—	na podlaze obj.
60	429	neinv.	celý	—	svor	—	ve výplni obj.

Přehled 9. SEKEROVITÉ HŘÍVNÝ

Poř. čís.	Čís. obj.	Invent. číslo	Zachovalost	Délka v mm	Šířka v mm	Tvar otvoru	Typ	Poznámka	Tab.
1	178	155.624	zlomek	78	10	obdél.	II	—	70:5
2	197	156.512	celá	135	17	kruh.	III	2 zlomky	75:7
3	210	157.125	zlomek	260	37	obdél.	II	2 zl. tyl. odl.	81:9
4	256	158.424	zlomek	134	25	—	—	tyl odlomen	97:4
5	273	158.667	zlomek	70	—	oválný	—	poškozena	101:4
6	344	163.322	zlomek	88	13	obdél.	IIa	—	126:1
7	361	164.913	zlomek	35	—	kruh.	III	—	134:2
8	412	172.325	celá	195	23	obdél.	IIa	3 zlomky	152:7

Přehled 10. BROUSKY

Poř. čís.	Čís. obj.	Invent. číslo	Typ	Počet brusných ploch	Délka v mm	Šířka v mm	Síla v mm	Druh kamene	Tab.
1	9	39.254		2	85	67	22	pískovec	5:8
2	14	127.496		2	140	75	16	břidlice ?	7:10
3	49	129.573	I Ib	2	83	64	9	pískovec	22:7
4	57	130.780	I Ib	2	128	65	25	břidlice	24:5
5	57	130.782	Ib	rýha	72	66	13	pískovec	24:4
6	69	132.842	Ia	1	120	35	34	prach. břidlice	30:11
7	77	133.885	I Ib	3	74	33	8	břidlice	35:9
8	86	134.404	I Ib	3	60	22	7	břidlice	37:1
9	132	140.471	Ib	rýhy	105	120		pískovec	52:3
10	139	142.740		1	60	45	13	břidlice	—
11	139	142.741	IIa	4	57	20	11	břidlice	—
12	142	143.194	III	4	110	40		xylolit	57:9
13	147	152.427	Ia	1	90	53	19	prachovec	58:5
14	165	153.265	IIa	3	87	29	10	?	65:5
15	173	154.987	Ib	rýhy	75	62	22	píšč. vápenec	68:2
16	182	155.716	Ia	1	33	42	4	břidlice	70:9
17	188	155.981	III	1	115	68	47	pískovec	72:5
18	209	156.865	III	1	110	37	45	vápn. prachovec	81:1
19	219	157.406	Ia	4	63	40	18	břidlice	85:6
20	231	157.676	Ia	1	170	50	67	pískovec	89:1
21	232	157.970	Ib	1, rýhy	100	35	68	pískovec	90:1
22	233	157.973	II	2	131	46	8	břidlice	90:5
23	236	158.080	Ia	1	65	45	13	pískovec	91:2
24	252	158.343	III	5	85	61	21	pískovec	96:3
25	264	158.483	II	2	41	22	2	břidlice	100:1
26	275	158.723	I Ib	2	140	62	10	břidlice	103:5
27	275	158.772	III	4	190	35	24	pískovec	103:4
28	294	161.400	II	2	48	37	9	břidlice	113:4
29	316	162.082	III	2	92	67	36	pískovec	118:7
30	322	162.152	I Ib	2	72	41	16	pískovec	120:3
31	328	162.700	I Ib	4	84	35	14	pískovec	122:2
32	328	162.699	III	4	73	27	24	prachovec	122:1
33	347	163.603	IIIb	4	98	32	15	břidlice	127:4
34	347	163.607	II	2	90	38	16	prachovec	127:5
35	347	163.606	I Ib	4	99	42	13	břidlice	127:6
36	352	164.310	Ia	1	50	53	11	břidlice	129:9
37	369	168.319	IIa	2	95	49	10	prachovec	135:1
38	373	168.476	Ia	1	108	60	24	prachovec	136:6
39	374	168.531	III	1	86	35	20	pískovec	137:5
40	377	168.731	Ia	1	35	24	3	vápn. slíd. pískov.	138:2
41	378	169.109	III	4	103	25	20	břidlice	139:16
42	378	169.110	III	3	66	40	21	vápn. pískovec	139:15
43	388	170.917	Ia	1	115	66	28	zelená břidlice	143:15
44	412	172.330	Ia	1	165	40	33	prach. břidlice	152:9
45	sběr	159.145	Ia	1	60	30	11	—	—
46	sběr	144.502	I Ib	4	50	38	15	prachovec	—
47	sběr	127.480		sekerka	73	40	25	břidlice	—
48	sběr	127.479		sekerka	50.	30	20	břidlice	—

Typ brousku: Ia — amorfní s širší brusnou plochou; Ib — amorfní s brusnými rýhami; II — destičkovité; IIa — destičkovité s 2 širšími brusnými plochami; IIb — destičkovité se 4 brusnými plochami; III — hranolovitě

Přehled 11. ŽELEZNÉ ŠIPKY

Poř. čís.	Číslo obj.	Invent. číslo	Tulejko- vité	Řapovité	Délka v mm	Poznámka	Tab.
1	1	38.502	—	rombická	55	zach. jen čepel	1:7
2	44	129.394	zpět. háč.	—	62	—	20:5
3	203	156.773	—	listovitá	51	část řapu odlom.	78:7
4	219	157.403	—	rombická	55	—	85:3
5	328	162.696	listovitá	—	53	čepel odlámána	122:7
6	347	163.602	—	rombická	57	—	127:3
7	349	163.704	—	trojúhel.	45	—	128:4
8	358	164.704	trojúhel.	—	60	část čepele odlom.	132:5
9	382	169.657	listovitá	—	67	čepel poškozena	140:4
10	388	170.904	—	rombická	64	—	143:12
11	417	172.828	?	—	23	jen zl. tulejky	154:6

Přehled 12. ŽELEZNÉ KROUŽKY

Poř. čís.	Čís. obj.	Invent. číslo	Prům. v mm	Síla v mm	Průřez	Poznámka	Tab.
1	122	137.934	38	7	kruhový	přelož. konce	48:2
2	152	152.702	36	3	kruhový	dotýk. se konce	62:1
3	328	162.695	34	7	oválný	ploché	122:8
4	358	164.717	40	5	—	ve zlomcích	—
5	388	170.902	20	3	obdélný	nedovřený	142:4
6	431	174.406	?	3	kruhový	zlomky	158:2
7	L 7—87	144.211	37	6	kruhový	přelož. konce	—

Přehled 13a. KOVÁNÍ VĚDER — RUKOJETI

Poř. čís.	Čís. obj.	Invent. číslo	Délka v mm	Ukončení rukojeti	Poznámka	Tab.
1	14	126.828	—	hákovité	zlomek	10:3
2	14	126.853	220	hákovité	—	10:6
3	14	126.843	140	—	zlomky	10:6a
4	14	126.837	300	hákovité	tordovaná	10:5
5	14	126.837/2	220	—	zlomky	—
6	150	125.608	220	knoflíkov.	—	61:5
7	231	157.670	120	hákovité	—	89:3
8	358	164.714	—	hákovité	zlomek	132:6
9	358	164.713	140	hákovité	—	132:6
10	358	164.712	160	hákovité	—	132:6
11	358	164.711	180	hákovité	—	132:6
12	358	164.716	—	knoflíkov.	—	—
13	358	164.719	160	—	zlomek	—
14	358	164.715	—	hák. s očkem	—	—
15	359	164.747	—	—	zlomek	133:1

Přehled 13b. KOVÁNÍ VĚDER — ATAŠE

Poř. čís.	Čís. obj.	Invent. číslo	Tvar	Délka v mm	Šířka v mm	Tab.
1	21	127.154	lichoběžník.	91	42	12:6
2	140	142.750	tyčinkovité	65	—	56:17
3	150	152.611	tyčinkovité	73	—	61:8
4	150	152.611	lichob. rozekl.	71	—	61:10
5	178	155.624	tyčinkovité	39	—	70:4
6	321	162.115	tyčinkovité	60	—	119:2
7	349	163.703	lichoběžník.	30	29	128:2
8	358	164.708	lichoběžník.	56	33	132:12
9	358	164.709	lichoběžník.	32	22	132:11
10	358	164.707	tyčinkovité	30	17	132:10
11	358	164.706	ovál. s očkem	47	18	132:9
12	358	164.705	tyčinkovité	56	72	132:8
13	416	172.626	tyčinkovité	68	65	153:4

Přehled 13. KOVÁNÍ VĚDER — OBROUČKY

Poř. čís.	Čís. obj.	Invent. číslo	Počet zlom.	Průřez obroučky	Průměr obr. v mm	Šířka v mm	Tab.
1	14	126.833	4	páskový	200	6	10:1
2	14	126.834	4	půlkruh.	260	10	10:2
3	14	126.835	19	půlkruh.	200	7	10:3
4	14	126.836	18	půlkruh.	160	6	10:4
5	14	126.837	2	půlkruh.	290	7	10:5
6	14	126.837	1	oválný	240	7	10:5
7	14	126.837	2	oválný	260	18	10:5
8	14	126.838	5	páskový	300	23	10:6
9	14	126.839	9	páskový	240	18	10:6a
10	14	126.840	5	půlkruh.	220	11	10:6a
11	14	126.841	5	půlkruh.	240	7	10:6a
12	14	126.842	12	půlkruh.	220	9	10:6a
13	14	126.843	1	půlkruh.	140	8	10:6
14	14	126.844	1	půlkruh.	120	9	10:6
15	14	126.845	3	páskový	300	32	10:7
16	14	126.845	2	půlkruh.	260	7	10:7
17	14	126.846	2	páskový	200	20	10:8
18	14	126.846	5	oválný	240	7	10:8
19	14	126.847	2	páskový	200	19	10:9
20	14	126.847	1	oválný	—	5	10:9
21	14	126.848	5	oválný	240	8	10:9
22	14	126.849	8	půlkruh.	250	10	10:11
23	14	126.850	1	půlkruh.	240	11	10:11
24	14	126.851	9	oválný	260	8	10:11
25	14	126.852	7	oválný	240	7	10:11
26	14	126.854	2	oválný	—	11	—
27	31	127.553	1	oválný	—	7	—
28	40	128.464	2	oválný	—	9	19:3,4
29	41	128.483	1	páskový	—	8	—
30	44	129.396	1	oválný	—	7	20:6
31	70	133.241	1	oválný	—	7	31:1
32	77	133.877	2	oválný	—	7	35:4
33	115	137.164	1	oválný	—	9	46:4
34	131	140.387	5	oválný	—	6	52:1
35	142	143.193	2	oválný	—	5	57:4
36	147	152.426	7	půlkruh.	—	5	58:4
37	150	152.609	38	půlkruh	280	9	61:4
38	151	152.690	2	oválný	—	4	60:3,4
39	176	155.146	2	oválný	—	7	69:1,2
40	178	155.624	1	oválný	—	9	70:3

Přehled 13. KOVÁNÍ VĚDER — OBROUČKY (pokračování 1)

Poř. čís.	Čís. obj.	Invent. číslo	Počet zlom.	Průřez obroučky	Průměr obr. v mm	Šířka v mm	Tab.
41	182	155.714	2	půlkruh	—	7	70:6,7
42	210	157.127	1	půlkruh	—	6	81:7
43	216	157.215	1	půlkruh	—	15	—
44	271	158.660	1	oválný	—	6	101:1
45	274	158.702	1	páskový	—	23	103:2
46	282	158.846	8	oválný	—	16	109:3
47	292	161.187	1	páskový	—	9	111:2
48	316	162.081	1	páskový	—	11	—
49	321	162.115	1	oválný	—	7	119:1
50	358	164.710	1	páskový	—	18	—
51	358	164.719	7	oválný	—	7	—
52	361	164.912	2	oválný	—	6	134:1
53	362	164.918	1	oválný	—	5	134:3
54	363	165.016	1	páskový	—	11	134:4
55	379	169.226	2	půlkruh.	—	11	139:18
56	388	170.900	2	půlkruh.	—	8	142:1
57	411	172.042	1	páskový	—	12	151:1
58	416	172.627	1	páskový	—	—	153:3
59	429	172.627	1	půlkruh.	—	7	157:11
60	429	174.237	1	páskový	—	—	157:9
61	281	158.842	1	páskový	—	12	107:4
62	282	158.845	1	páskový	—	45	109:4

Přehled 14. NOŽE

Poř. čís.	Čís. obj.	Invent. číslo	Zachovalost	Délka v mm	Šířka v mm	* Hřbet	** Ostří	Poznámka	Tab.
1	14	126.830	zlom.	40	19	—	—	—	7:6
2	14	126.822	celý	120	8	Z	S	—	7:5
3	17	127.054	zlom.	98	11	R	O	—	11:3
4	44	129.395	zlom.	—	—	—	—	—	20:7
5	47	129.468	zlom.	100	16	Z	O	krevní rýha	21:1
6	48	129.506	zlom.	69	17	Š	O	dřevoobráběcí ?	21:5
7	56	130.033	celý	123	15	Z	O	—	23:1
8	57	130.778	čepel	75	10	R	O	úzký — stolový ?	24:1
9	64	131.088	celý	135	15	Z	O	—	26:1
10	67	132.150	celý	148	18	Z	O	krev. rýha, boj. ?	28:1
11	67	132.152	zlom.	75	—	—	—	—	28:5
12	68	132.786	zlom.	51	13	Z	O	—	29:4
13	70	133.242	zlom.	70	11	—	—	—	31:4
14	78	133.904	zlom.	58	—	—	—	—	34:1
15	82	134.165	čepel	82	14	Z	O	—	36:1
16	86	134.402	zlom.	47	15	—	—	—	37:1
17	88	134.633	zlom.	66	13	—	—	—	38:2
18	91	134.852	celý	150	18	R	O	krev. rýha, boj.	38:3
19	93	134.880	zlom.	102	9	Z	O	—	39:3
20	115	137.165	celý	116	14	Z	O	—	46:6
21	115	137.161	zlom.	64	19	—	—	—	46:2
22	121	137.714	zlom.	65	12	—	—	—	48:6
23	123	138.230	celý	115	12	R	O	hrot odlomen	49:3
24	129	140.264	zlom.	90	—	—	—	—	51:2
25	135	140.851	zlom.	50	—	—	—	—	53:2
26	139	142.730	celý	175	18	Z	O	bojový	56:12
27	139	142.731	čepel	83	17	K	O	—	56:1
28	139	142.732	zlom.	83	18	Z	O	—	56:9

Přehled 14. NOŽE (pokračování 1)

Poř. čís.	Čís. obj.	Invent. číslo	Zachovalost	Délka v mm	Šířka v mm	* Hřbet	** Ostří	Poznámka	Tab.
29	139	142.733	zlom.	105	15	—	—	—	56:6
30	139	142.733	zlom.	75	—	—	—	—	56:4
31	144	143.232	zlom.	80	—	—	—	—	58:7
32	165	153.261	celý	88	—	R	V	prsterec u řapu	65:2
33	173	154.986	zlom.	55	10	—	—	—	68:3
34	177	155.448	celý	150	20	Z	O	bojový	69:7
35	177	155.450	zlom.	78	19	—	—	—	69:8
36	178	155.625	zlom.	—	—	—	—	—	70:5
37	184	155.865	zlom.	30	—	Z	—	—	72:2
38	195	156.248	čepel	82	14	Z	O	—	74:1,2
39	196	156.382	zlom.	79	18	—	—	masivní trn	75:2
40	197	156.512	zlom.	—	—	—	—	—	75:7
41	210	157.124	celý	135	17	Z	S	silně zbroušený	81:3
42	215	157.197	celý	100	14	R	O	—	83:1
43	216	157.215	zlom.	97	15	—	—	—	83:4
44	218	157.217	zlom.	—	—	—	—	—	—
45	219	157.402	celý	114	13	Z	O	—	85:2
46	232	157.963	čepel	107	18	Z	O	—	90:2
47	241	158.171	zlom.	74	22	Z	O	—	93:1
48	253	158.357	zlom.	91	—	Z	O	—	96:4
49	254	158.360	zlom.	97	19	—	—	—	—
50	258	158.428	zlom.	—	—	—	—	—	—
51	273	158.666	celý	77	12	K	O	—	101:5
52	278	158.882	čepel	78	14	R	O	—	106:1
53	281	158.842	čepel	92	16	—	—	—	107:5
54	289	161.097	celý	161	24	Z	O	bojový	110:1
55	295	161.610	zlom.	52	18	Z	O	—	113:5
56	314	162.024	zlom.	74	19	Z	O	—	118:2
57	315	162.030	zlom.	122	18	—	—	—	118:4
58	320	162.114	čepel	87	15	—	—	—	—
59	322	162.151	zlom.	—	—	—	—	—	119:3
60	336	162.944	čepel	111	19	Z	O	—	124:4
61	344	163.323	zlom.	54	—	—	—	zachován jen trn	126:5
62	349	163.702	zlom.	145	16	—	S	bojový	128:3
63	350	163.718	zlom.	79	18	—	—	obuvnický nůž ?	129:2
64	351	163.750	zlom.	40	—	Z	O	zachován jen hrot	129:3
65	352	164.309	celý	87	15	Z	O	—	129:4
66	352	164.309	zlom.	68	18	—	—	—	129:10
67	352	164.309	zlom.	72	10	—	—	—	129:5
68	354	164.456	celý	108	15	Z	O	—	131:3
69	355	164.640	zlom.	118	11	Z	O	—	131:4
70	355	164.639	čepel	100	13	—	O	zvednutý hrot	131:5
71	360	164.857	zlom.	96	16	Z	O	—	133:3
72	363	165.015	celý	79	15	R	O	—	134:5
73	369	168.381	zlom.	105	—	—	—	—	135:3
74	372	168.414	celý	80	14	—	—	—	135:5
75	374	168.530	zlom.	109	—	Z	O	—	137:2
76	377	168.729	zlom.	33	—	—	—	—	138:4
77	379	169.224	zlom.	76	17	Z	O	—	139:20
78	379	169.225	zlom.	65	17	—	—	—	134:5
79	381	169.451	zlom.	30	10	Z	O	—	135:3
80	385	169.676	zlom.	76	14	—	—	—	135:5
81	388	170.905	čepel	92	15	Z	O	—	143:8
82	388	170.906	celý	100	11	Z	O	—	143:10
83	391	171.052	zlom.	118	17	—	—	hrot odlomen	144:4
84	391	171.053	čepel	99	18	Z	O	krevní rýha	144:3
85	394	171.298	zlom.	70	12	—	—	—	145:1
86	409	171.855	zlom.	51	11	Z	O	—	147:2
87	411	172.040	čepel	77	12	R	O	—	151:4
88	413	172.458	zlom.	82	20	—	—	—	153:2

Přehled 14. NOŽE (pokračování 2)

Poř. čís.	Čís. obj.	Invent. číslo	Zachovalost	Délka v mm	Šířka v mm	* Hřbet	** Ostří	Poznámka	Tab.
89	423	173.044	zlom.	77	12	R	O	—	156:1
90	424	173.066	zlom.	40	21	Z	O	—	156:5
91	429	174.235	zlom.	71	19	Z	S	—	157:1
92	429	174.235	zlom.	53	14	—	—	—	157:2
93	432	174.457	zlom.	139	17	R	O	—	158:4
94	435	174.574	zlom.	97	13	—	—	—	160:2
95	sběr	39.857	celý	161	21	R	O	bojový	162:8
96	sběr	39.856	celý	113	18	R	K	obuvnický nůž ?	162:9

* Hřbet: R — rovný, Z — rovný, k hrotu zkosený, K — klenutý — Š — šikmý vzhledem k ose

** Ostří: O — ostří rovné, k hrotu obloukovitě zvednuté
S — esovitě vybroušené ostří
V — silně vybroušené ostří
K — vně vyklenuté ostří

Přehled 15. PŘESLENY

Poř. čís.	Čís. obj.	Invent. číslo	Materiál	Tvar	Zachovalost	Prům. v mm	Výška v mm	Poznámka	Tab.
1	2	38.640	H	2	celý	42	19	—	2:5
2	4	38.768	H	1	celý	25	18	otlučený	3:4
3	9	39.231	H	1a	celý	30	17	—	5:7
4	11	126.567	K	1	celý	23	15	—	7:2
5	43	129.065	K	1	zlom.	29	18	—	20:4
6	57	130.781	K	1	celý	25	20	—	24:3
7	68	132.769	K	1	celý	23	20	vodorovné rýhov.	29:5
8	89	134.726	K	1	celý	24	18	—	38:1
9	124	138.234	K	1	celý	21	18	—	49:1
10	124	138.233	K	2	celý	31	21	hráněný	49:2
11	142	143.195	H	2	celý	28	19	—	57:11
12	154	168.268	?	1	zlom.	?	15	—	—
13	225	157.494	?	3	celý	26	18	zkosené okraje	88:2
14	231	157.675	K	1	zlom.	24	16	—	89:8
15	294	161.402	H	1	celý	39	16	základna konkáv.	113:2
16	303	161.807	H	1	celý	25	14	otlučený	115:1
17	324	162.172	H	1a	celý	32	19	—	121:1
18	328	162.698	K	2	zlom.	27	15	—	122:5
19	328	162.697	K	2	celý	26	15	—	122:6
20	352	164.313	H	2	celý	28	14	—	129:6
21	358	164.722	K	1	celý	28	17	—	132:2
22	358	164.723	K	1	celý	27	17	—	132:3
23	358	164.721	K	2	celý	26	18	—	132:4
24	378	169.108	K	1	zlom.	27	17	—	139:8
25	378	169.108	K	1	zlom.	20	12	—	139:10
26	378	169.108	K	2	zlom.	?	13	—	139:9
27	385	169.678	H	2	celý	23	14	zdoben vpichy	141:2
28	388	170.915		2	zlom.	26	17	—	142:3
29	416	172.628		2	zlom.			—	153:5
30	420	172.982		1a	celý	28	17	—	155:3
31	420	172.983		1	celý	22	11	—	155:4
32	429	174.243		1a	celý	42	26	—	157:7
33	432	174.459		1	celý	40	23	vypouklý lom	158:6
34	435	174.576		2	zlom.	68		otlučen	160:1
35	L 11—82	40.223		2	celý	34	24	—	162:1

* Materiál: H — hliněný, K — kamenný

** Tvar: 1 — dvoukónický, 1a — dvoukónický asymetrický
2 — bochánkovitý, 3 — válcovitý

Přehled 16. HLINĚNÁ ZÁVAŽÍ

Poř. čís.	Čís. obj.	Invent. číslo	Zachovalost	Průměr v mm	Výška v mm	Poznámka	Tab.
1	183	155.812	polovina	83	78	válcovité	71:6
2	187	155.980	zlomek	63	74	—	72:4
3	382	169.659	zlomek	—	—	—	140:5
4	386	169.724	polovina	95	95	bochánkovité	141:6
5	388	170.916	zlomek	—	—	—	142:5

Přehled 17. KOSTĚNÉ PROPLĚTÁČKY

Poř. čís.	Čís. obj.	Invent. číslo	Zachovalost	Délka v mm	Určení kosti	Poznámka	Tab.
1	2	38.671	celý	84	Ovis-capra	bez epifyzy	2:3
2	6	39.054	zlomek	91	Ovis-capra	—	4:1
3	6	39.055	celý	90	Ovis-capra	—	4:2
4	6	39.091	celý	97	Ovis-capra	srovnaná hlavice	4:4
5	11	126.568	zlomek	84	Ovis-capra	—	7:1
6	13	126.751	celý	106	Ovis-capra	srovnaná hlavice	7:3
7	26	127.353	zlomek	59	Ovis-capra	—	13:4
8	35	128.168	celý	74	Ovis	—	18:1
9	43	129.064	celý	93	Ovis-capra	—	20:3
10	67	144.076	zlomek	68	Ovis-capra	—	28:4
11	70	133.243	zlomek	67	Ovis-capra	klešťkovité ukonč.	31:3
12	107	135.844	zlomek	130	Ovis-capra	—	42:2
13	110	136.436	zlomek	88	Ovis-capra	—	43:6
14	120	137.523	zlomek	69	Ovis-capra	—	48:3
15	127	139.349	celý	107	Ovis-capra	—	50:1
16	127	139.350	celý	93	Bos	šídlo masivní	50:2
17	127	139.351	celý	59	Ovis-capra	bez epifyzy, lešť.	50:3
18	128	139.806	zlomek	79	Ovis-capra	—	49:5
19	129	140.266	celý	73	Ovis-capra	bez epifyzy	51:5
20	129	140.267	celý	72	Ovis-capra	srovnaná hlavice	51:4
21	129	140.268	celý	85	Ovis-capra	—	51:1
22	135	140.852	zlomek	94	Ovis-capra	—	53:1
23	139	142.738	celý	80	Ovis-capra	bez epifyzy	56:13
24	139	142.735	zlomek	75	Ovis-capra	—	56:14
25	142	143.196	zlomek		Cervus	—	57:12
26	145	143.440	celý	80	Ovis-capra	bez epifyzy	58:3
27	145	143.441	celý	115	Ovis-capra	—	58:2
28	165	153.264	zlomek	132	Ovis-capra	—	64:4
29	165	153.263	celý	82	Ovis capra	—	65:3
30	168	153.636	zlomek	84	Ovis capra	—	67:1
31	170	154.604	celý	80	?	—	67:2
32	176	155.148	zlomek	83	Ovis capra	—	69:3
33	176	155.149	celý	85	Bos?	šídlo masivní	69:4
34	177	155.451	celý	82	Capreolus	—	69:9
35	178	155.627	celý	72	Ovis-capra	—	70:1
36	178	155.626	celý	82	Sus	bez epifyzy	70:2
37	182	155.715	celý	102	Ovis	—	70:8
38	195	156.250	zlomek	125	Ovis-capra	—	74:6
39	195	156.249	celý	119	Ovis-capra	—	74:5
40	200	156.560	zlomek	122	Ovis-capra	—	76:1
41	204	156.774	celý	82	Ovis	—	80:1
42	210	157.128	celý	99	Ovis-capra	otvor shora	81:2
43	210	157.129	zlomek	122	Ovis-capra	podélně rozštíp.	81:5
44	215	157.198	celý	77	Ovis-capra	otvor shora	83:2
45	219	157.405	celý	93	Bos	srovnaná hlavice	85:4
46	225	157.495	celý	89	?	—	88:1
47	231	157.674	zlomek	100	?	podélně rozštíp.	89:2

Přehled 17. KOSTĚNĚ PROPLĚTAČKY (pokračování 1)

Poř. čís.	Čís. obj.	Invent. číslo	Zachovalost	Délka v mm	Určení kosti	Poznámka	Tab.
48	231	157.871	zlomek	100	?	—	89:4
49	231	157.893	celý	77	?	—	89:5
50	232	157.966	celý	107	Ovis-capra	—	90:8
51	232	157.967	celý	108	Ovis	—	90:10
52	232	157.968	celý	87	Ovis	—	90:12
53	232	157.969	celý	63	Ovis-capra	otvor shora	90:11
54	250	158.310	celý	100	Ovis-capra	—	95:1
55	270	158.650	celý	78	Bos	šídlo masivní	100:2
56	273	158.668	celý	70	Ovis-capra	—	101:6
57	278	158.824	celý	108	Ovis-capra	otvor shora	106:3
58	293	161.322	zlomek	48	?	jen hrot	113:1
59	294	161.401	celý	87	?	bez epifyzy	113:3
60	304	161.846	zlomek	96	Ovis-capra	—	116:2
61	307	161.865	zlomek	94	Ovis-capra	—	116:3
62	308	161.918	celý	127	Ovis-capra	šídlo	117:3
63	314	162.026	celý	95	Ovis-capra	—	118:1
64	325	162.185	celý	130	Ovis-capra	—	121:2
65	328	162.701	celý	41	Ovis-capra	podélně rozštíplý	122:9
66	344	163.328	zlomek	48	Ovis-capra	—	126:4
67	344	163.325	celý	123	Canis	šídlo masivní	126:3
68	344	163.327	zlomek	48	Ovis-capra	—	126:4
69	344	163.326	zlomek	100	Ovis-capra	—	126:7
70	347	163.604	celý	103	Ovis-capra	otvor boční	127:1
71	352	164.311	celý	78	Ovis-capra	srovnaná hlavice	129:1
72	352	164.312	celý	64	Lepus	jemný kus	129:8
73	355	164.642	zlomek	73	Ovis-capra	—	131:7
74	373	168.477	celý	97	Capra	—	136:5
75	377	168.730	zlomek	73	Ovis-capra	—	138:3
76	378	169.100	celý	78	Ovis-capra	—	139:6
77	378	169.107	zlomek	60	Ovis-capra	—	139:7
78	381	169.452	celý	95	Bos	šídlo masivní	140:2
79	382	169.658	celý	73	Sus	bez epifyzy	140:3
80	385	169.677	celý	103	Ovis	—	141:1
81	386	169.722	zlomek	90	Ovis-capra	srovnaná hlavice	141:7
82	388	170.908	celý	78	Ovis-capra	bez epifyzy	143:3
83	388	170.909	celý	87	Ovis-capra	—	143:2
84	388	170.910	celý	74	Ovis-capra	—	143:1
85	388	170.911	celý	170	Canis	šídlo masivní	143:18
86	388	170.912	celý	86	Capra	—	143:4
87	389	170.995	celý	80	Ovis	—	144:5
88	401	171.360	celý	91	Ovis	—	147:1
89	407	171.804	celý	138	Ovis-capra	—	149:2
90	407	171.805	zlomek	93	?	—	149:3
91	410	172.005	zlomek	80	Ovis-capra	—	151:6
92	410	172.006	zlomek	78	Ovis-capra	—	151:7
93	413	172.459	celý	102	Ovis-capra	bez epifyzy	153:1
94	429	174.240	zlomek	67	?	jen hrot	157:4
95	429	174.241	zlomek	115	?	—	157:1
96	429	174.242	zlomek	91	?	—	157:8

Přehled 18. KOSTĚNÉ BRUSLE

Poř. čís.	Čís. obj.	Invent. číslo	Zachova- lost	Délka v mm	Určení kosti	Nosec (ano—ne)	Tab.
1	7	39.179	celá	214	Equus — meta- carpus dx	ano	4:9
2	9	39.230	celá	240	Equus — meta- tarsus prox. sin.	ano	5:5
3	67	132.153	zlomek	160	Bos — radius prox. dx	—	28:12
4	67	144.074	celá	206	Equus — meta- carpus dx	ano	28:8
5	67	144.075	zlomek	125	Bos — radius prox. dx	—	28:8
6	71	133.392	zlomek	41	Equus — meta- tarsus prox. dx	—	32:1
7	72	133.716	celá	205	Equus — meta- carpus sin.	ano	32:2
8	129	140.268	zlomek	230	Bos — radius sin.	ne	51:3
9	278	158.823	zlomek	140	Equus — radius prox. dx	—	106:2
10	334	162.927	polotovar	165	Bos — meta- carpus dx.	ano	124:1
11	366	168.286		180	?	ano	134:6
12	388	170.914	celá	255	Equus — meta- tarsus sin.	ano	143:17
13	412	172.328	zlomek	210	Equus — meta- tarsus dx	ano	152:8

Přehled 19. ZVÍŘECÍ KOSTNÍ MATERIÁL Z JIŽNÍHO PŘEDHRADÍ BŘECLAVI—POHANSKA Z VÝZKUMU 1975—1978
Rozdělení na jednotlivé části skeletu a jejich počty

Část skeletu	Anser anser f. domestica	Gallus gallus f. domestica	Felis lybica f. catus	Canis lupus f. familiaris	Equus przewalski f. caballus	Sus scrofa f. domestica	Bos primigenius f. taurus	Ovis - capra	Castor fiber	Cricetus cricetus	Lepus europaeus	Sus scrofa	Cervus elaphus	Capreolus capreolus	Aves	Celkem
Os crani	—	—	1	16	12	498	250	33	—	1	—	1	—	—	—	812
Processus cornualis	—	—	—	—	—	—	77	17	—	—	—	—	—	1	—	95
Maxilla	—	—	—	—	2	62	30	17	2	—	—	—	—	—	—	113
Mandibula	—	—	—	20	20	634	297	190	1	—	—	—	—	—	—	1162
Dentes superiores	—	—	—	—	50	100	265	84	—	—	—	2	—	—	—	501
Dentes inferiores	—	—	—	34	22	401	249	137	—	—	—	1	—	—	—	844
Atlas	—	—	—	1	—	32	39	6	—	—	—	—	—	—	—	78
Axis	—	—	—	3	—	8	35	9	—	—	—	—	—	—	—	55
Os sacrum	—	—	—	—	1	—	18	1	—	—	—	—	—	—	—	20
Sternum	4	—	—	—	—	—	—	—	—	—	—	—	—	—	—	4
Scapula	1	6	—	11	10	205	171	68	—	—	1	2	—	—	—	475
Humerus	4	9	2	16	12	225	198	65	—	—	1	1	2	1	—	536
Radius	3	1	—	14	18	75	192	91	—	—	2	1	4	—	—	401
Ulna	2	6	1	14	7	133	78	7	1	—	1	1	—	—	—	251
Os carpi	—	—	—	—	14	4	38	—	—	—	—	—	—	—	—	56
Metacarpus	1	2	—	—	15	52	190	30	—	—	—	—	—	1	—	291
Pelvis	—	1	1	10	12	109	240	52	—	—	—	1	—	—	—	426
Femur	1	9	2	16	25	54	223	22	1	—	—	—	1	—	—	354
Patella	—	—	—	—	4	—	12	—	—	—	—	—	—	—	—	16
Tibia	1	18	4	19	13	152	226	120	—	—	3	—	—	—	1	557
Fibula	—	—	—	—	—	62	—	—	—	—	—	—	—	—	—	62
Talus	—	—	—	—	10	24	109	11	—	—	—	—	—	—	—	154
Calcaneus	—	—	—	1	7	38	119	8	—	—	—	1	4	—	—	178
Os tarsi	—	—	—	—	2	—	32	—	—	—	—	—	1	—	—	35
Metatarsus	3	9	—	17	15	33	172	35	—	—	—	—	—	—	—	284
Phalanx proximalis	—	—	—	—	15	25	164	14	—	—	—	—	—	—	—	218
Phalanx media	—	—	—	—	10	6	75	1	—	—	—	—	2	—	—	94
Phalanx distalis	—	—	—	—	15	2	59	—	—	—	—	—	—	—	—	76
Celkem	20	61	11	192	311	2934	3558	1015	5	1	8	11	14	3	1	8145
Neurčitelné	—	—	—	—	—	—	—	—	—	—	—	—	—	—	—	8320
Celkem	—	—	—	—	—	—	—	—	—	—	—	—	—	—	—	16 463

Přehled 20. PŘEHLED ZÍSKANÉHO ZVÍŘECÍHO KOSTNÍHO MATERIÁLU DOMÁCÍCH A VOLNĚ ŽIJÍCÍCH DRUHŮ Z JEDNOTLIVÝCH LET VÝZKUMŮ NA JIŽNÍM PŘEDHRADÍ HRADISKA BŘECLAVI—POHANSKA

Zvířecí druh	1975	1976	1977	1978	Celkem	v %
Anser anser	—	16	1	3	20	0,2
f. domestica						
Gallus gallus	2	33	15	11	61	0,7
f. domestica						
Felis lybica	—	1	8	2	11	0,2
f. catus						
Canis lupus	—	22	168	2	192	2,3
f. familiaris						
Equus przewalski	20	147	115	29	311	3,8
f. caballus						
Sus scrofa	179	1 636	677	443	2 935	36,1
f. domestica						
Bos primigenius	392	1 715	963	488	3 558	43,7
f. taurus						
Ovis-Capra	52	510	260	190	1 015	12,5
Castor fiber	5	—	—	—	5	
Cricetus cric.	—	1	—	—	1	
Lepus europaeus	2	5	—	1	8	
Sus scrofa	6	—	4	1	11	0,5
Cervus elaphus	6	7	1	—	14	
Capreolus	1	1	1	—	3	
capreolus						
Aves	—	1	—	—	1	
Celkem	665	4 095	2 213	1 170	8 143	100
Neurčitelné	1 041	3 264	2 592	1 423	8 320	
Celkem	1 706	7 359	4 805	2 593	16 463	

Přehled 21. POROVNÁNÍ POČTU KOSTNÍCH ZBYTKŮ Z HRADIŠTĚ MĚSTSKÉHO TYPU V MIKULČICÍCH, Z KNÍŽECÍHO DVORCE HRADISKA BŘECLAVI—POHANSKA, ZE SÍDLIŠTNÍCH OBJEKTŮ NA PLOŠE HRADISKA POHANSKA MIMO KNÍŽECÍ DVOREC, ZE SÍDLIŠTNÍ AGLOMERACE NA JIŽNÍM PŘEDHRADÍ HRADISKA POHANSKA A Z HRADIŠTĚ PETROVA LÓUKA U STRACHOTINA. VYJÁDŘENO JEN PRO NEJPOČETNĚJI ZASTOUPENÁ DOMÁCÍ ZVÍRATA

Zvířecí druh	Mikulčice hradiště		Břeclav-Pohansko knížecí dvorec		Břeclav-Pohansko sídlíště mimo knížecí dvorec		Břeclav-Pohansko sídlíště na jižním předhradí		Strachotín hradiště Petrova louka	
	Počet kostí	v ‰	Počet kostí	v ‰	Počet kostí	v ‰	Počet kostí	v ‰	Počet kostí	v ‰
Sus scrofa f. domestica	116 294	48	5 605	47	2 123	37,1	2 935	39,1	256	29,2
Bos primigenius f. taurus	69 729	29,3	4 214	35	2 831	49,5	3 558	47,4	538	61,4
Ovis — Capra	52 056	21,9	2 182	18	762	13,4	1 015	13,5	82	9,4
Celkem	238 079	100,0	12 001	100,0	5 716	100,0	7 508	100,0	876	100,0

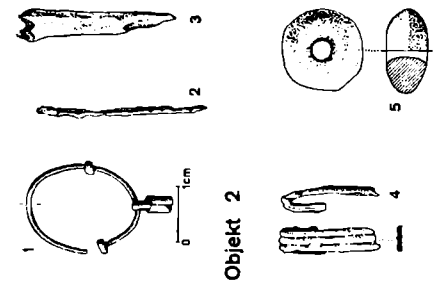
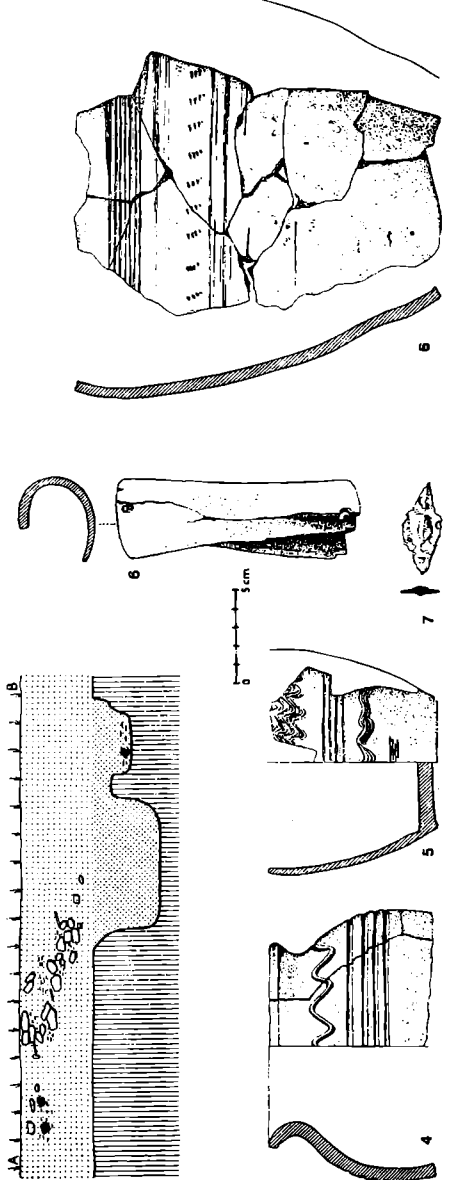
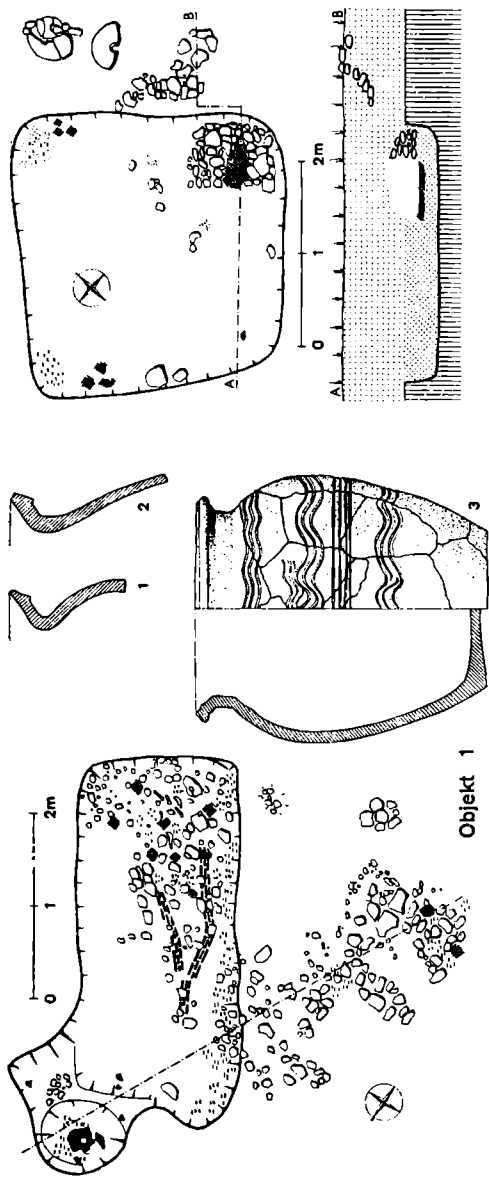

Objekt 2

Tab. 1. Obj. 1: 1-38230, 2-38446, 3-38563, 4-38447, 5-38526, 6-38487, 7-38502.
 Tab. 2. Obj. 2: 1-38672, 2-38631, 3-38671, 4-3868B, 5-38640, 6-38660, 7-38623, 8-38677.

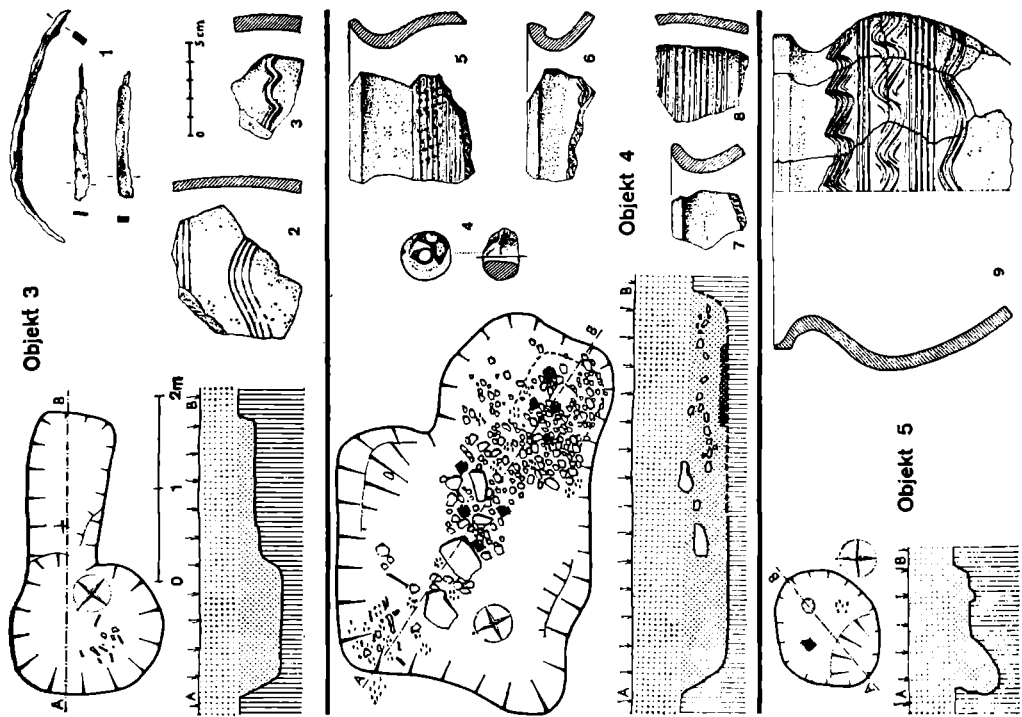

Tab. 3. Obj. 3: 1-38706, 2-38669, 3-38697; obj. 4: 4-38768, 5-38710, 38711, 7-38714, 8-38722; obj. 5: 9-38769.

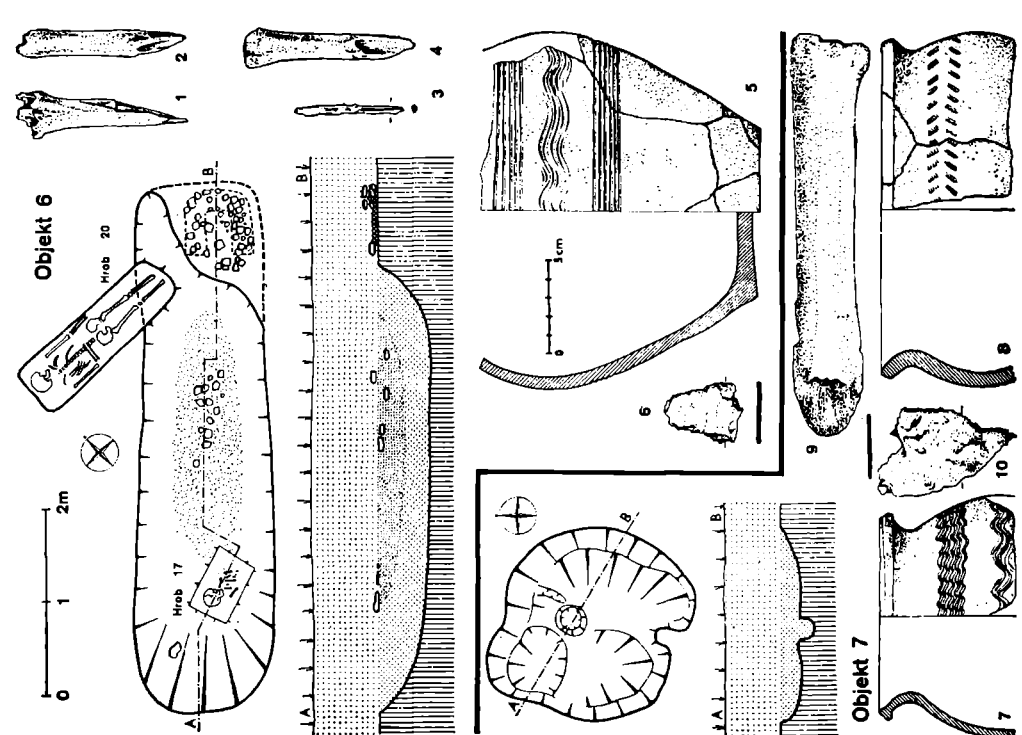

Tab. 4. Obj. 6: 1-39055, 2-38054, 3-38860, 4-39091, 5-30910, 6-38869; obj. 7: 7-39118, 8-39150, 9-39179, 10-39180.

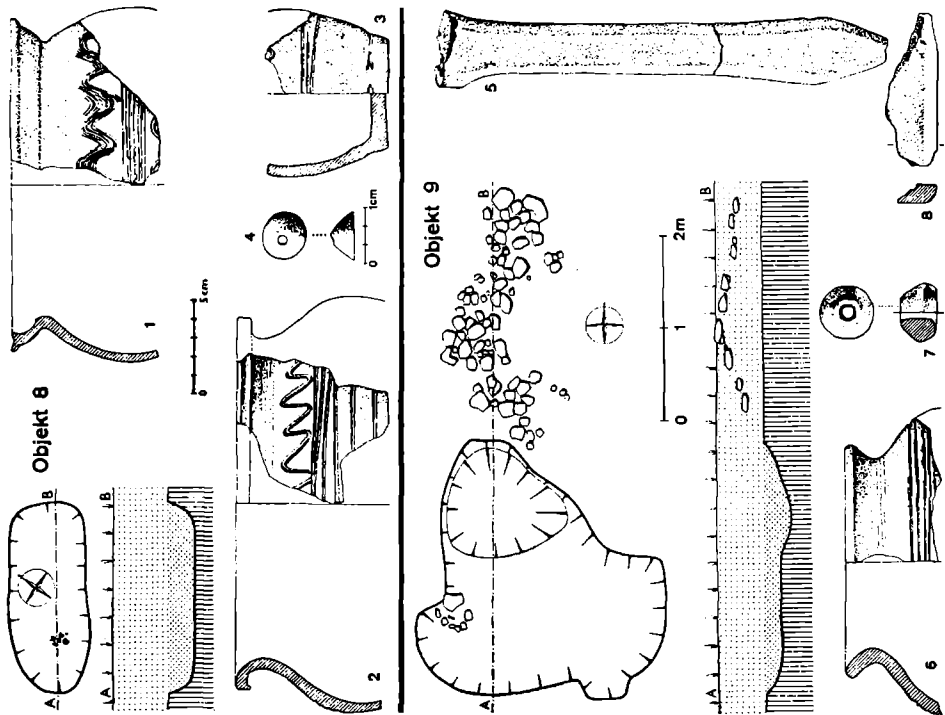

Таб. 5. Obj. 8: 1—39203, 2—39200, 3—39226, 4—39229; obj. 9: 5—39230, 6—39233, 7—39231, 8—39230.

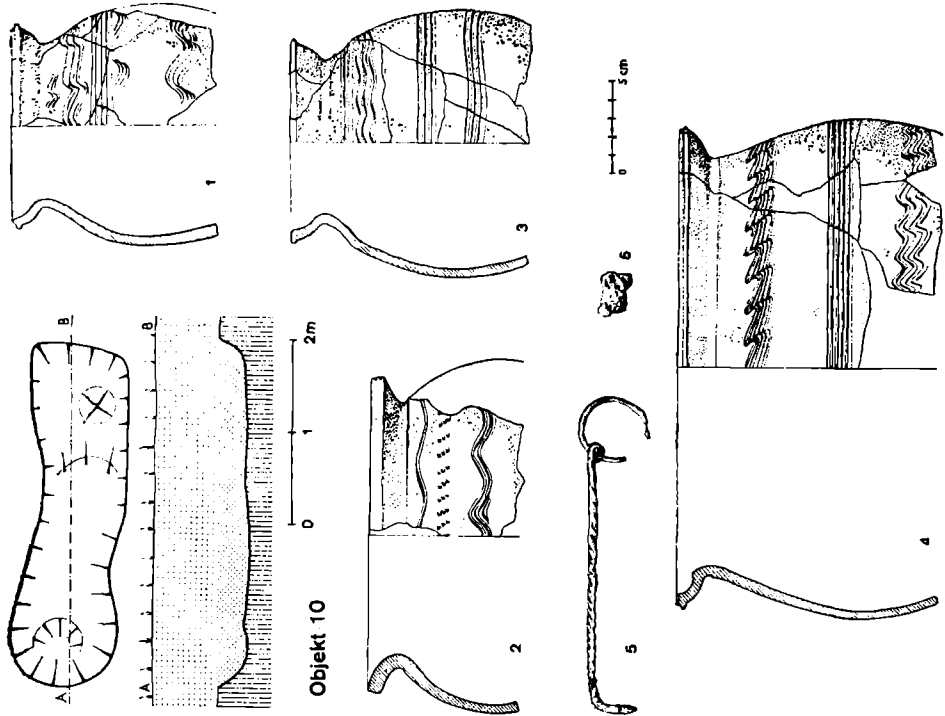

Таб. 6. Obj. 10: 1—39365, 2—39260, 3—39361, 4—39361, 5—39265, 6—39336.

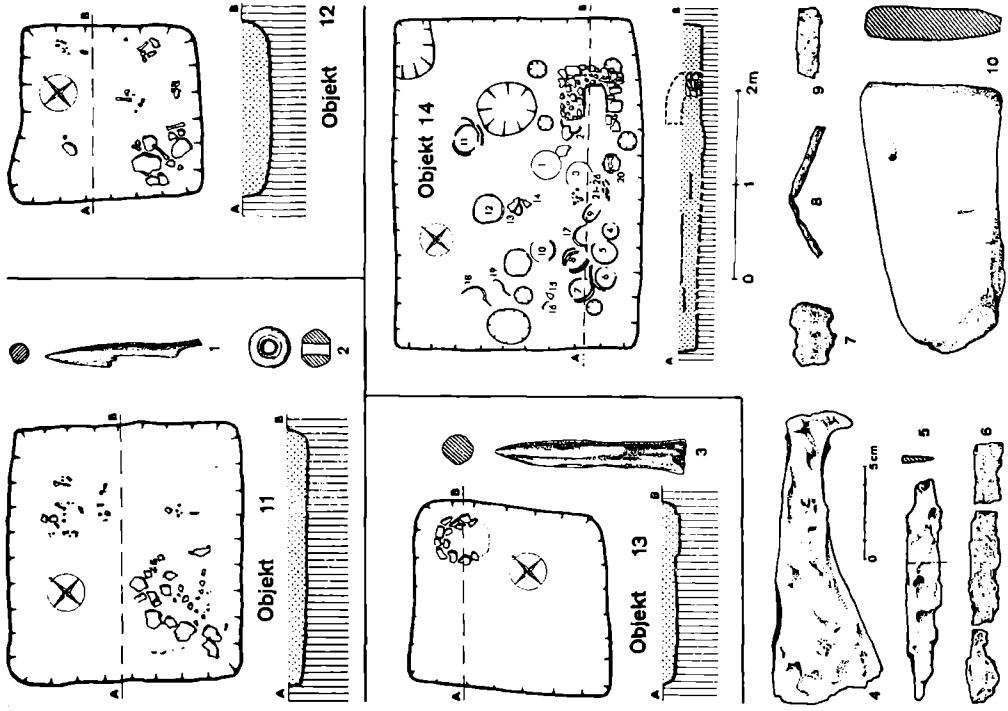

Tab. 7. Obj. 11: 1-126567, 2-126568; obj. 12: obj. 13: 3-126751; obj. 14: 4-126826, 5-126822, 6-126830, 7-126829, 8-126829/1, 9-126829/2, 10-127496.

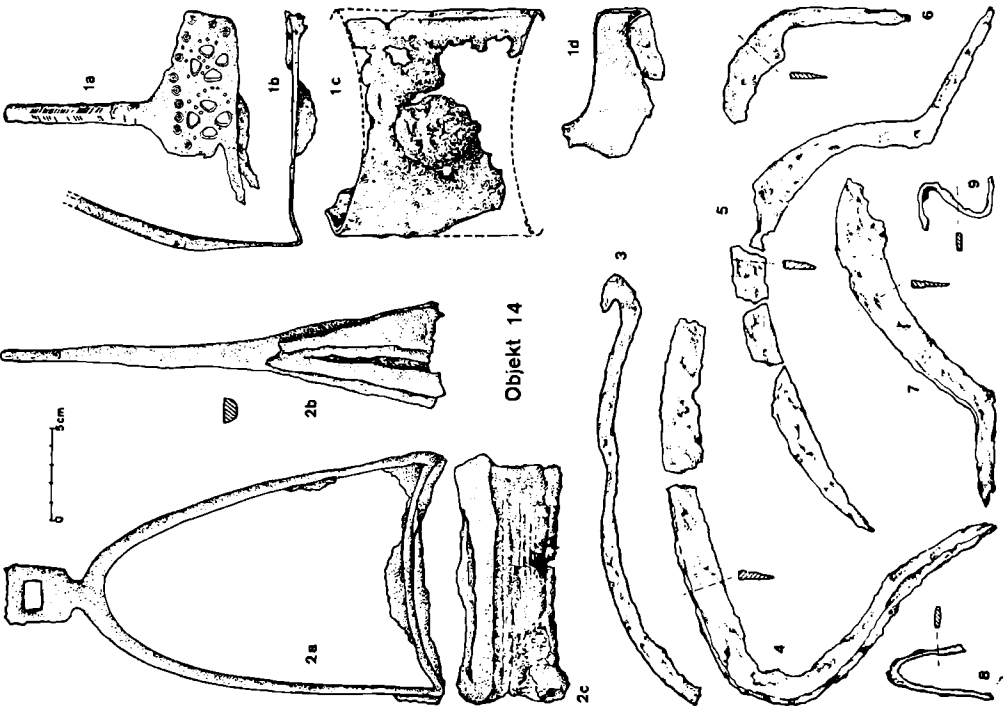

Tab. 8. Obj. 14: 1a, b, c, d-126824/1-5, 2a, b, c-126825, 3-126828, 4-126882, 5-126855, 6-126823, 7-126831, 8-126854 2, 9-126854/1.

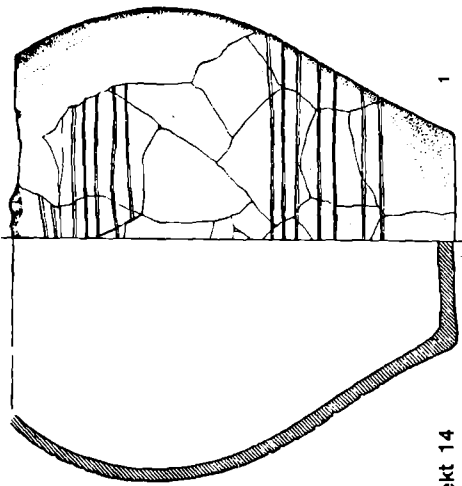

Objekt 14

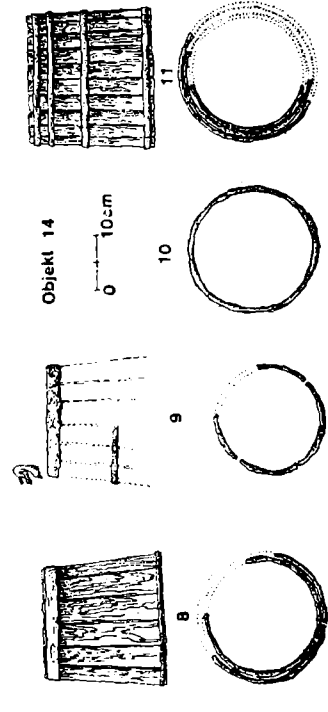
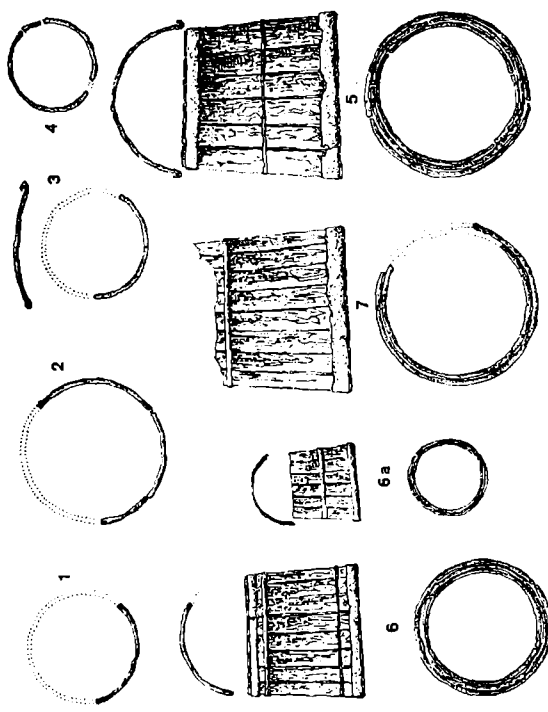
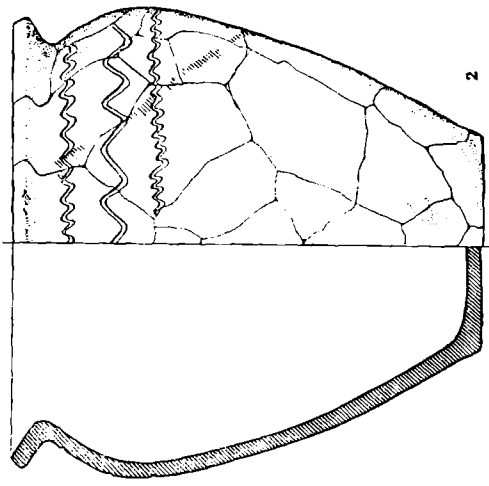

Objekt 14

Tab. 10. Obj. 14: 1-126634, 2-126634, 3-126635, 4-126636, 5-126637, 6.6a-126638, 7-126645, 8-126646, 9-126647, 10-126649, 11-126649.

Tab. 9. Obj. 14: 1-126771, 2-126770.

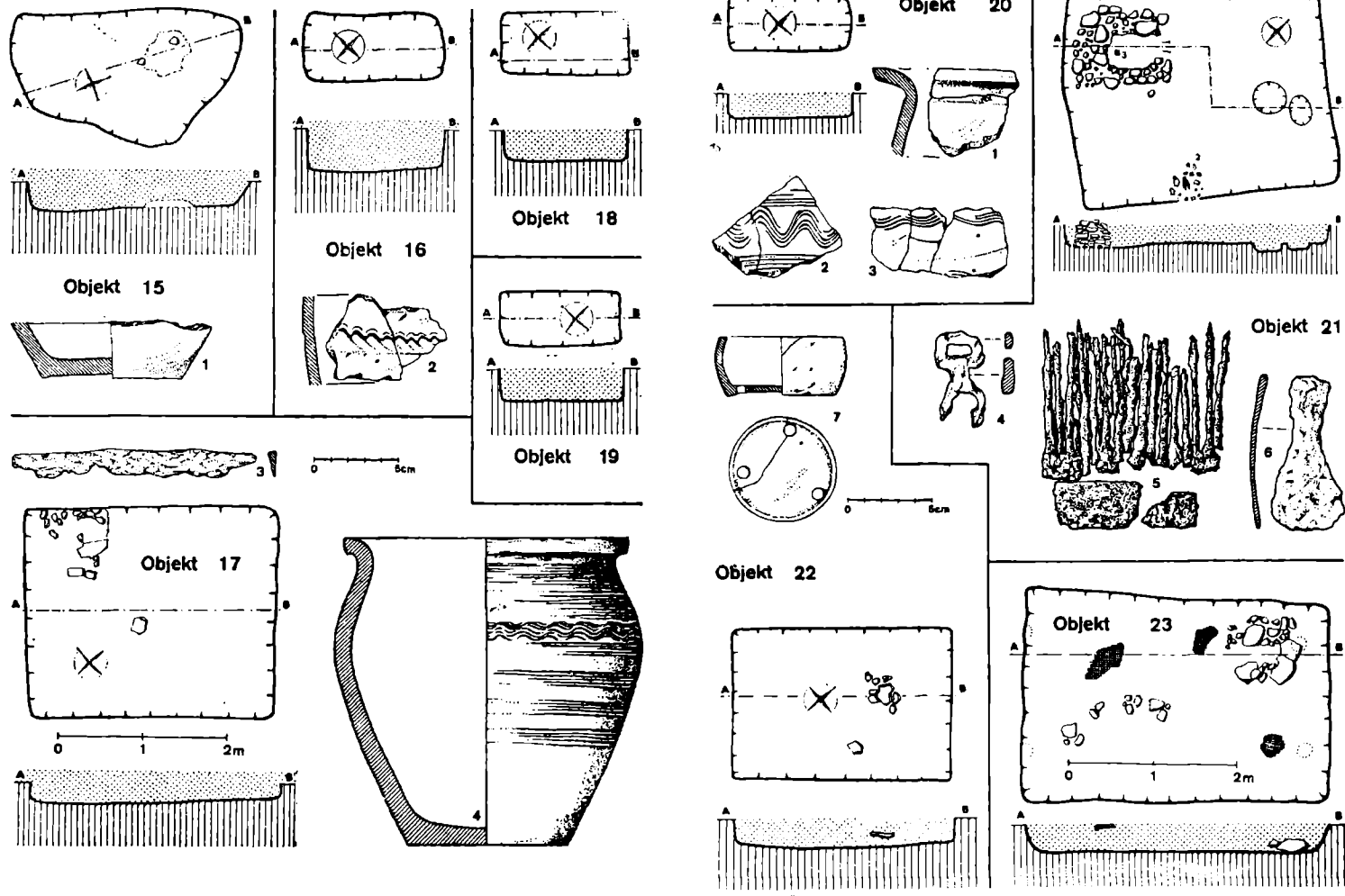

Tab. 11. Obj. 15: 1-126856; obj. 16: 2-126978; obj. 17: 3-127054, 4-127023; obj. 18; obj. 19.

Tab. 12. Obj. 20: 1-3-127084 1-3; obj. 21: 4-127155, 5-127156, 6-127154; obj. 22: 7-127498; obj. 23.

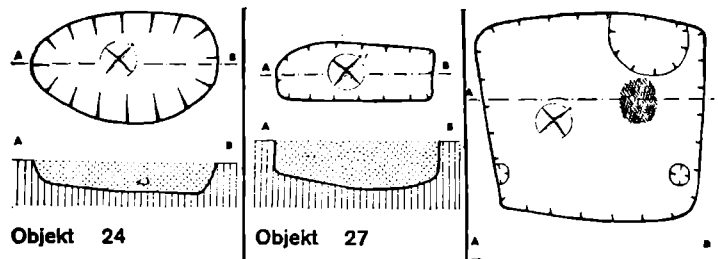

Objekt 24

Objekt 27

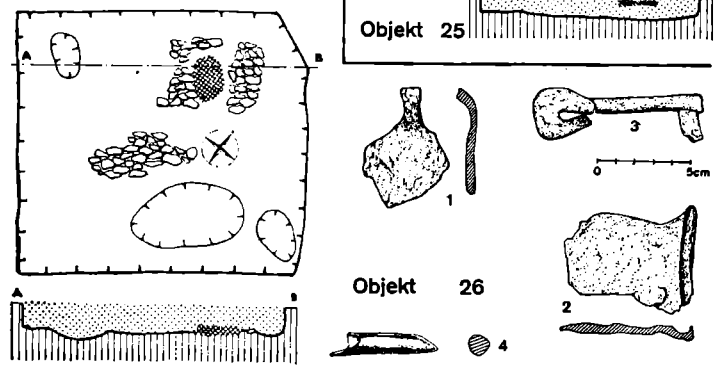

Objekt 25

Objekt 26

0 5cm

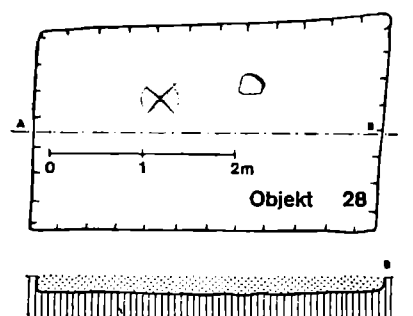

Objekt 28

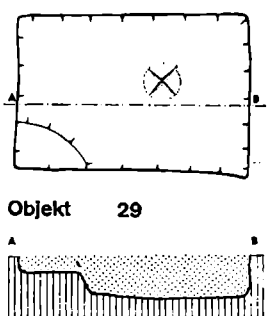

Objekt 29

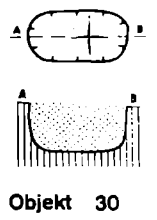

Objekt 30

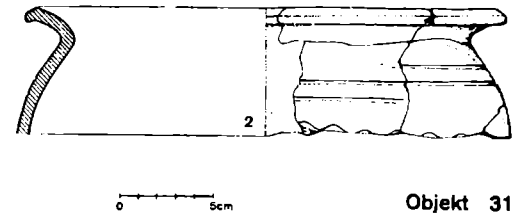

Objekt 31

0 5cm

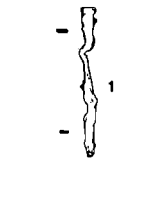

Objekt 32

0 1 2m

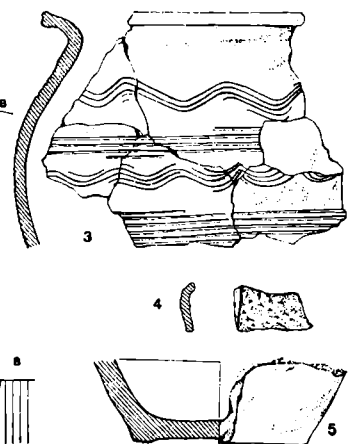

3

4

5

Tab. 13. Obj. 24; obj. 25; obj. 26: 1-127350, 2-3-127351, 4-127353; obj. 28; obj. 29.

Tab. 14. Obj. 30; obj. 31: 4-127553, 5-127543; obj. 32: 1-127556, 2-127718, 3-127651.

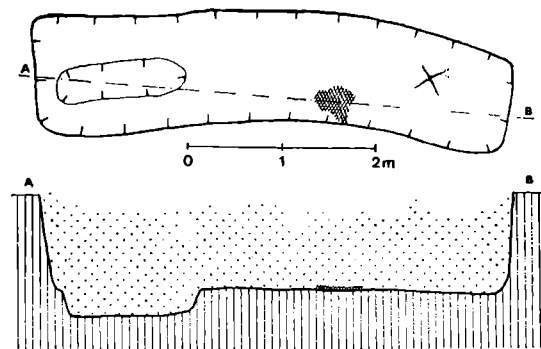

Objekt 33

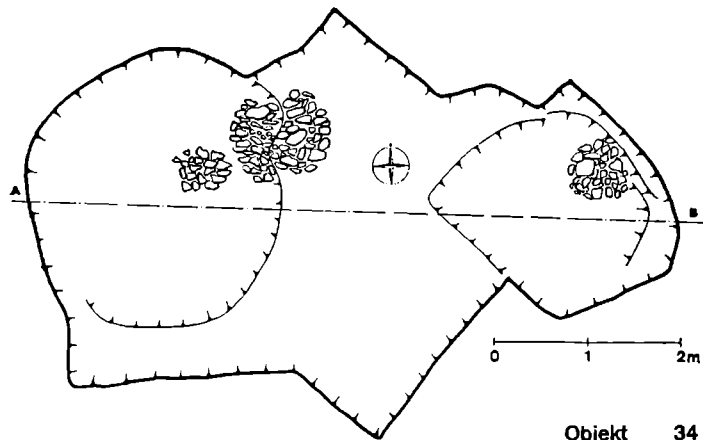

Objekt 34

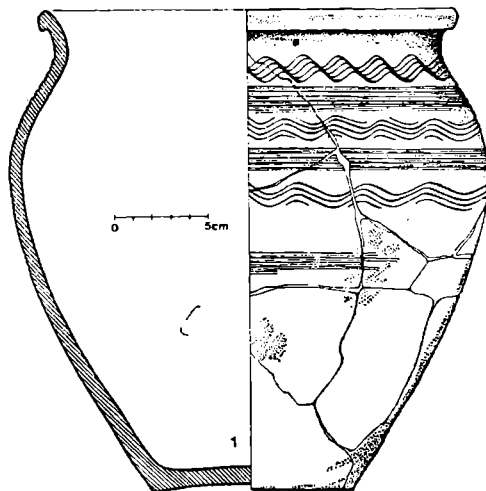

Tab. 15. Obj. 33: 1-127777.

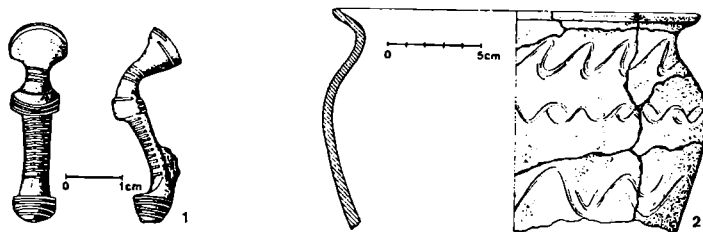
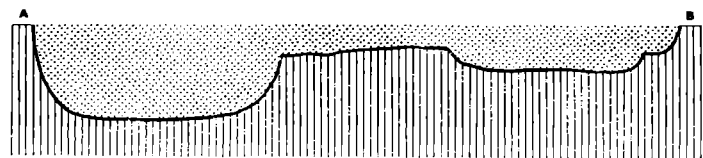

Tab. 16. Obj. 34: 1-128038, 2-152192.

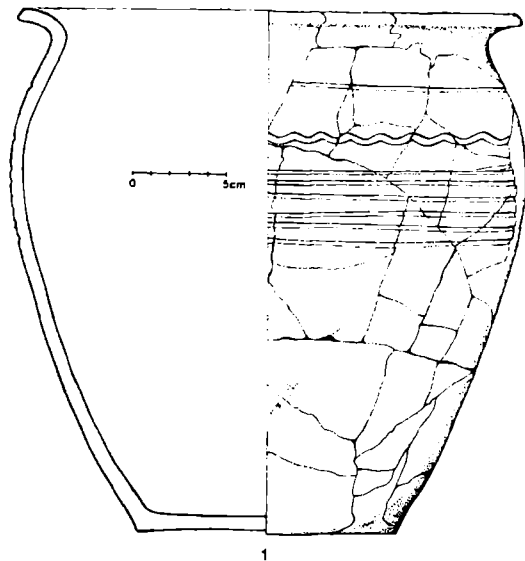

1

Objekt 34

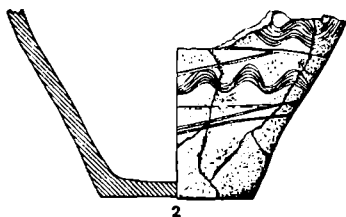

2

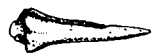
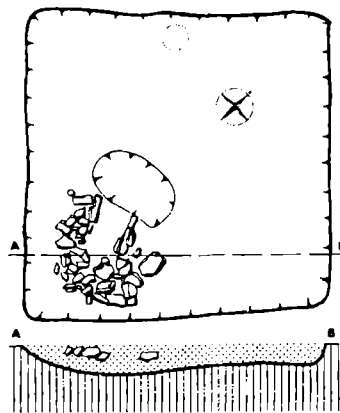

1 Objekt 35

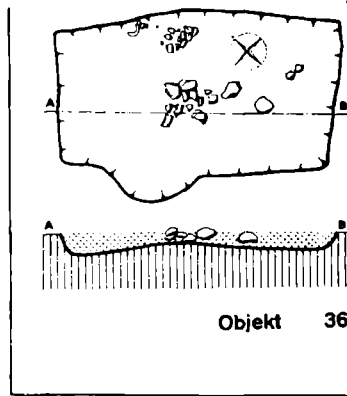

Objekt 36

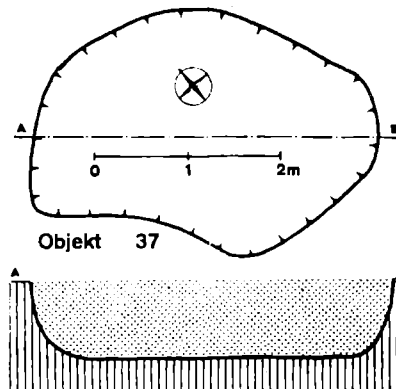

Objekt 37

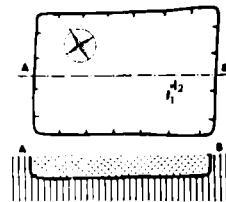

Objekt 38

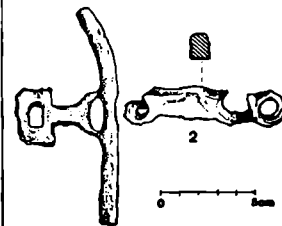

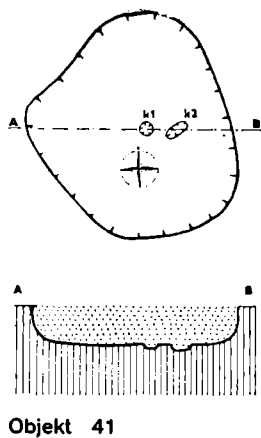
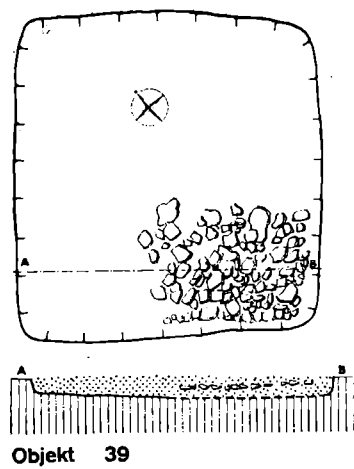

0 1 2m

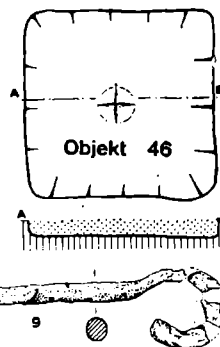
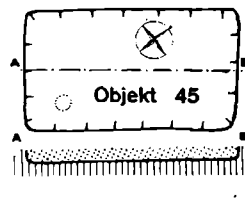
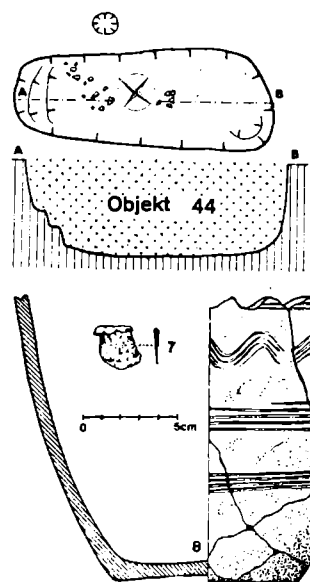
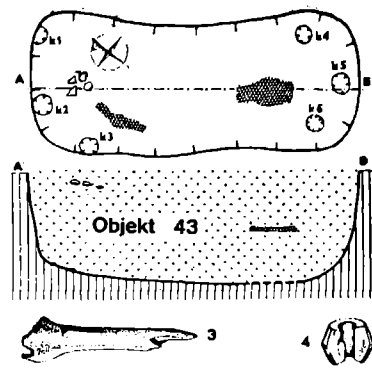
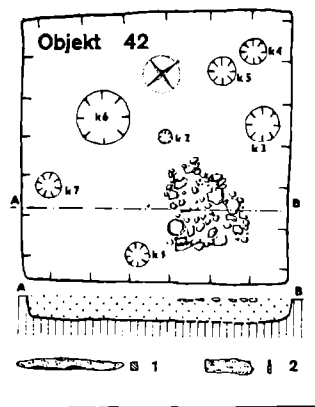
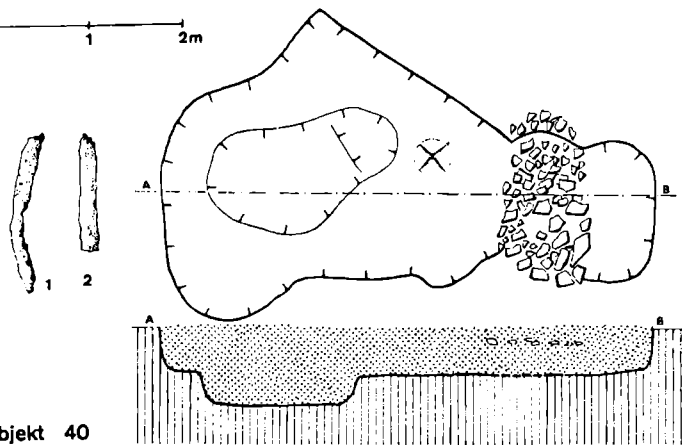

Tab. 20. Obj. 42: 1,2-neinv.; obj. 43: 3-129064, 4-129065; obj. 44: 5-129394,

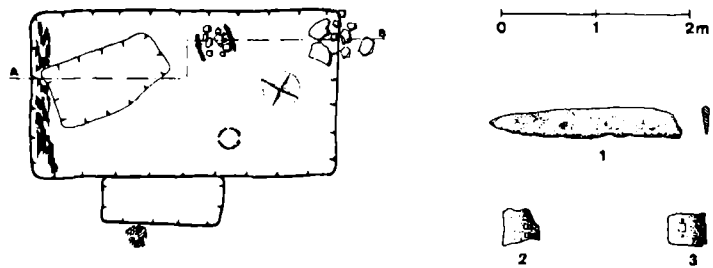

0 1 2m

Objekt 47

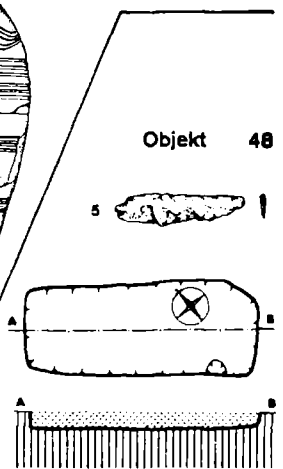
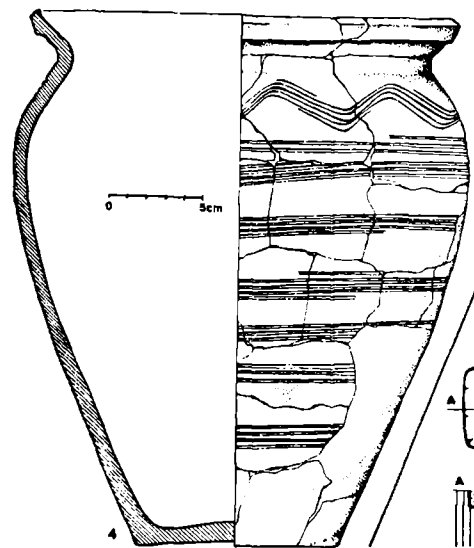

Objekt 48

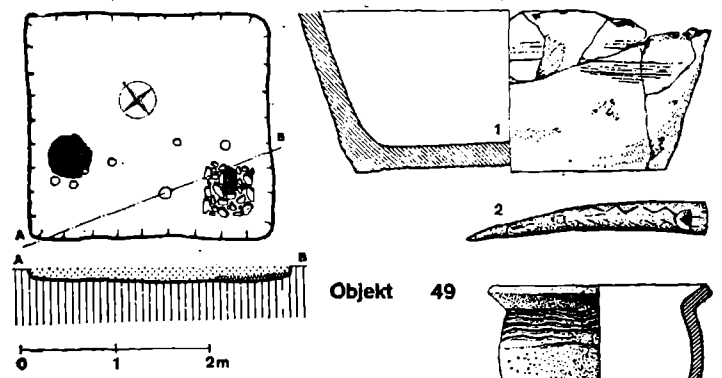

Objekt 49

0 1 2m

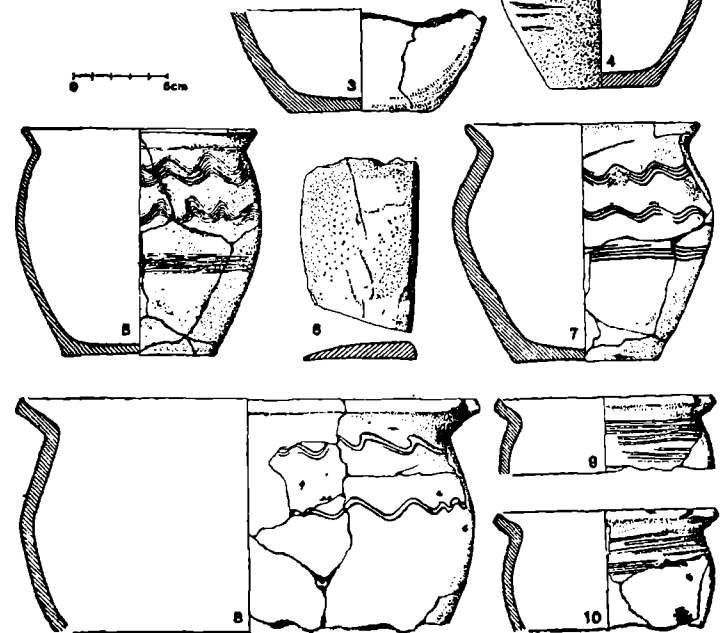

Tab. 22. Obj. 48: 1-129531, 2-129572, 3-129571, 4-129533, 5-129532, 6-129573, 7-129532, 8-129507, 9-129510, 10-129529.

Tab. 21. Obj. 47: 1-129468, 2,3-129467, 4-143617; obj. 48: 5-129506.

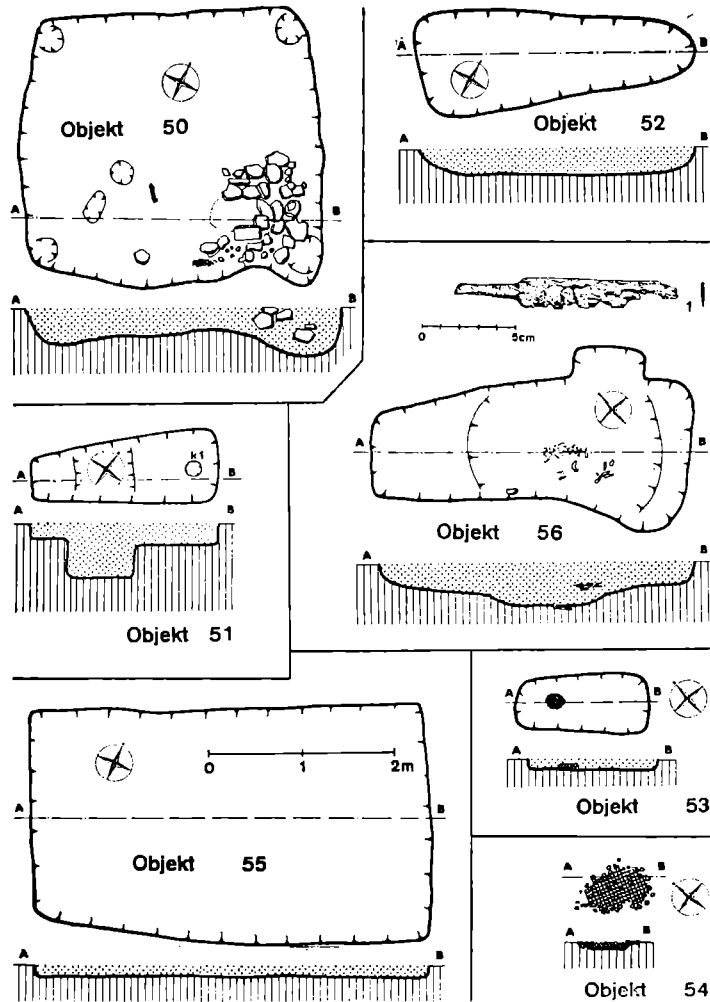

Tab. 23. Obj. 50; obj. 51; obj. 52; obj. 53; obj. 54; obj. 55; obj. 56: 1—130033.

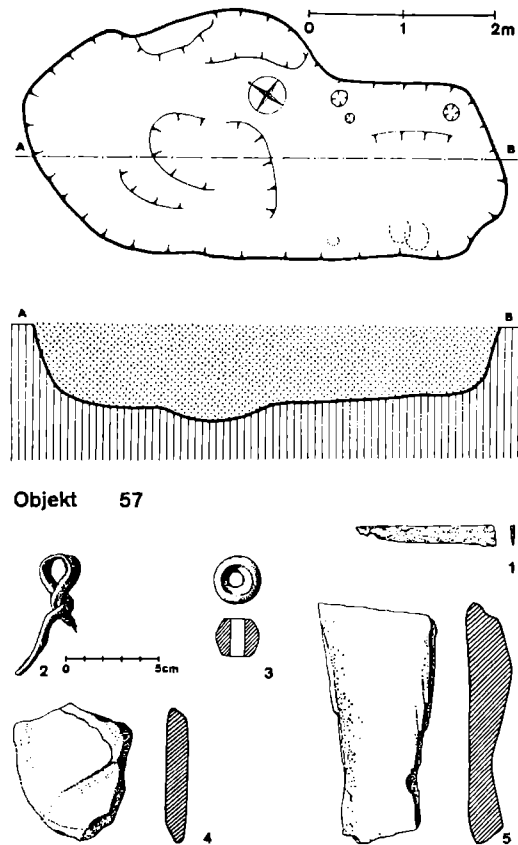

Tab. 24. Obj. 57: 1—130778, 2—130773, 3—130781, 4—130782, 5—130780.

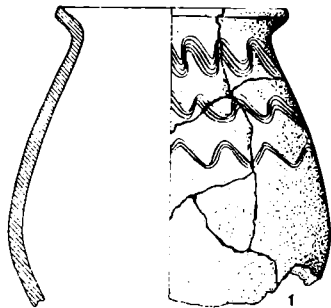
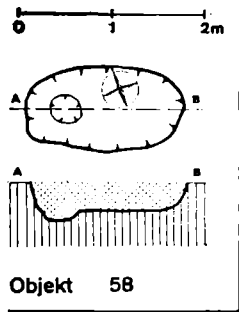

Objekt 59

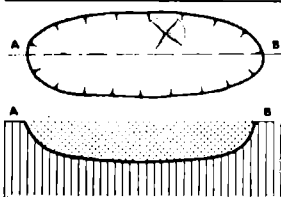
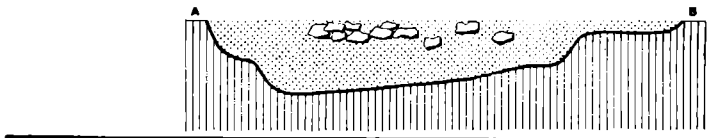
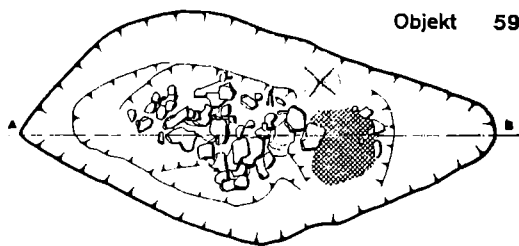

Objekt 60

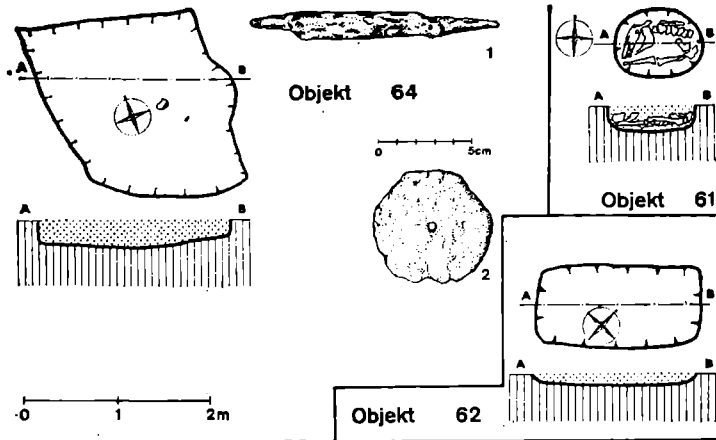
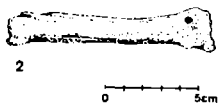

Objekt 64

Objekt 62

Objekt 63

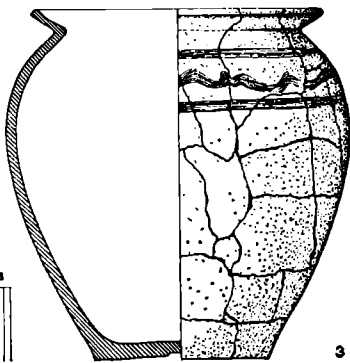
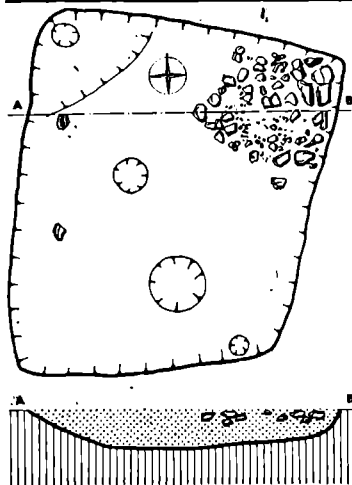

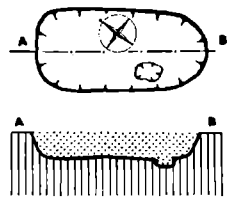

Objekt 65

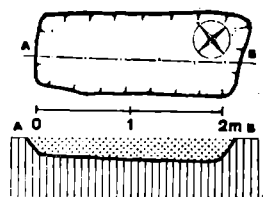

Objekt 66

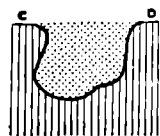
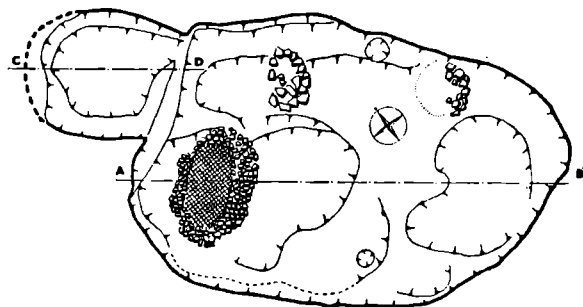

Objekt 67

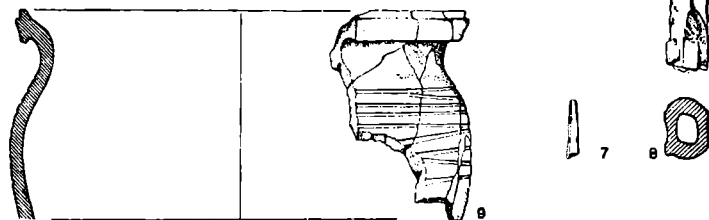
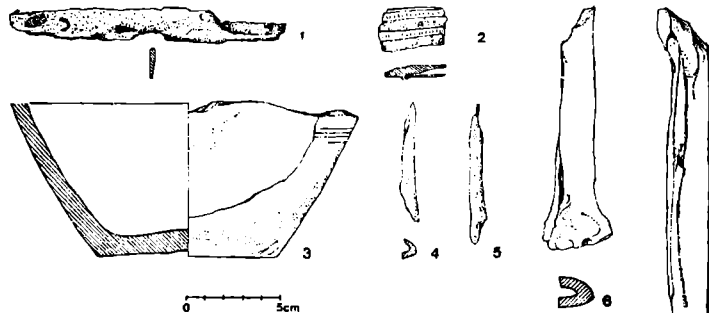
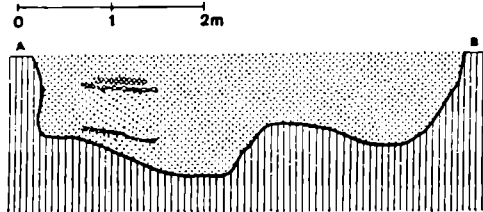

Objekt 67

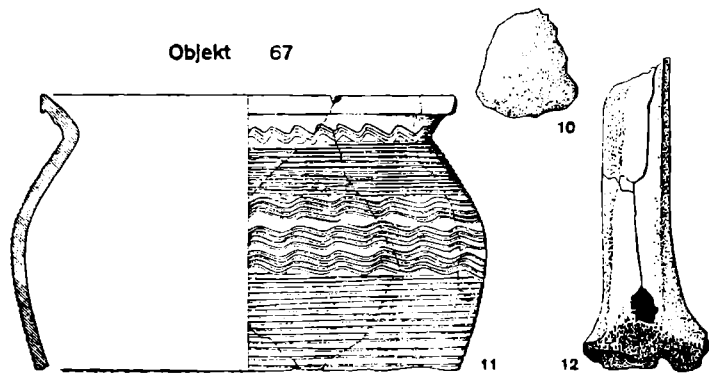

Tab. 27. Obj. 65; obj. 66; obj. 67.

Tab. 28. Obj. 67: 1-132150, 2-132149, 3-132318, 4,6,8,12-132153, 5-132152, 7-132151, 9-132317, 10-132148, 11-143837.

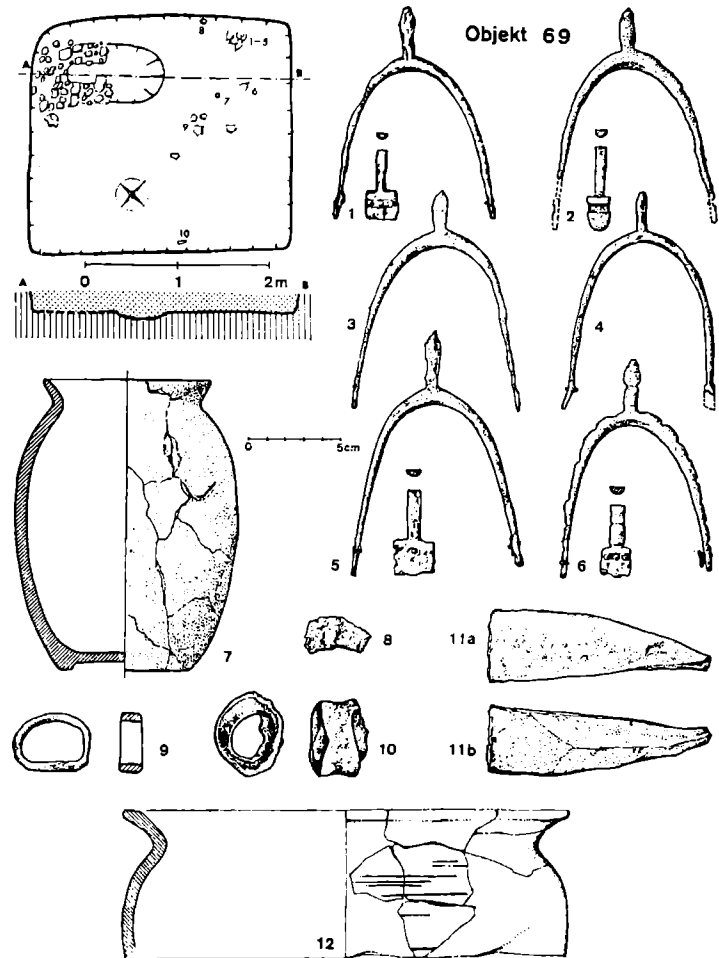
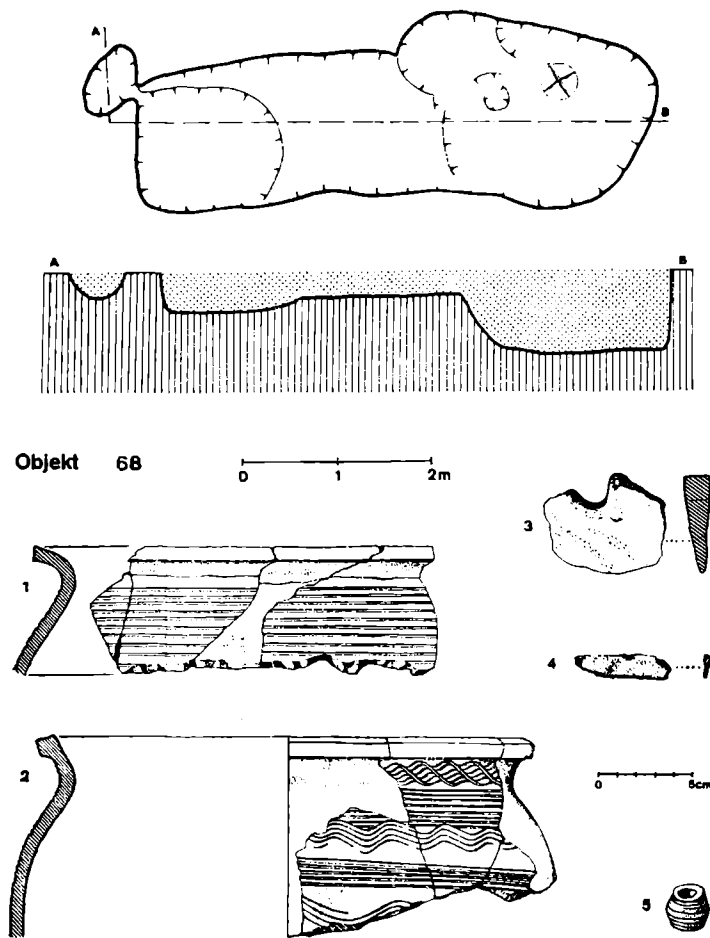

Tab. 29. Obj. 68: 1-144081, 2-144078, 3-132770, 4-132768, 5-132769.

Tab. 30. Obj. 69: 1-132836, 2-132839, 3-132838, 4-132837, 5-132834, 6-132835, 7-132798, 8-132833, 9-132841, 10-132840, 11a,b-132846, 12-132799.

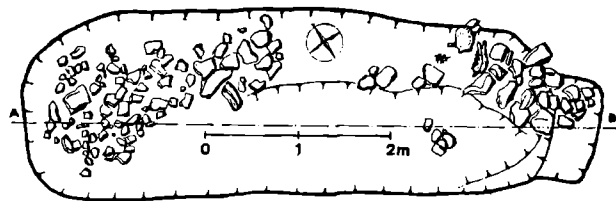

I. FÁZE

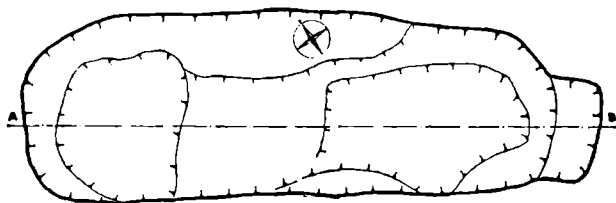

II. FÁZE

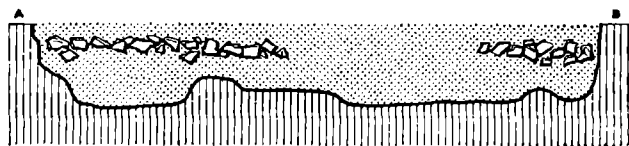

Objekt 70

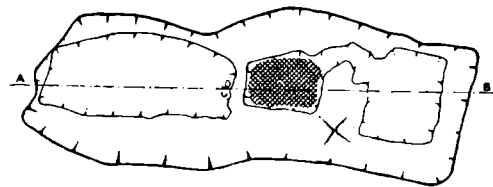
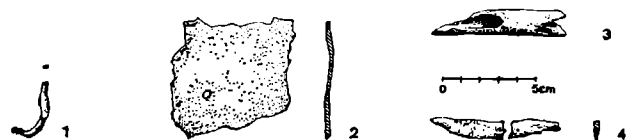

Objekt 71



Objekt 72

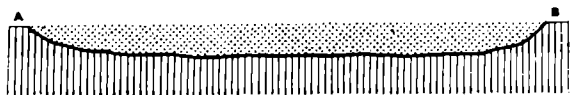
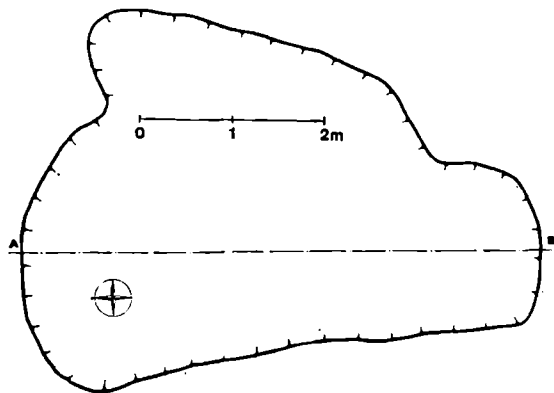

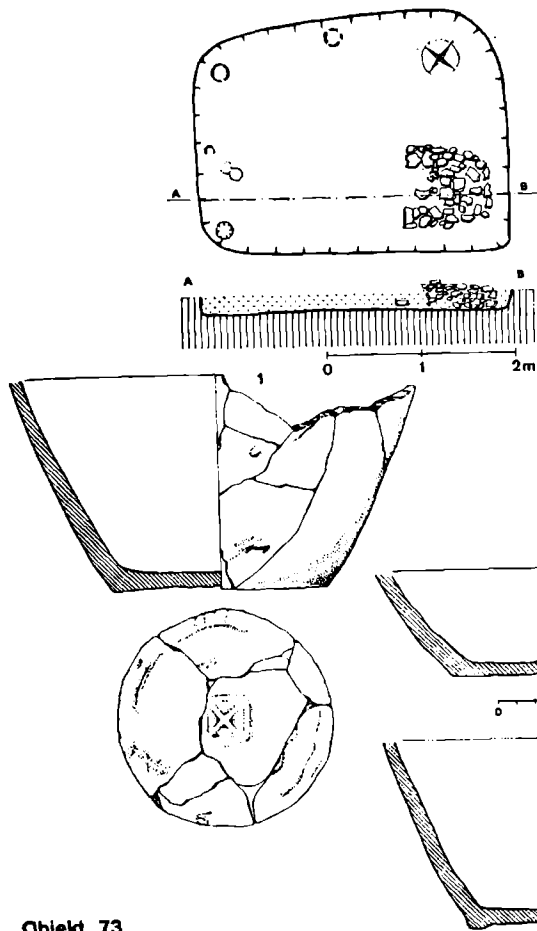

Objekt 73

Tab. 33. Obj. 73: 1—133719, 2—133720, 3—133721.

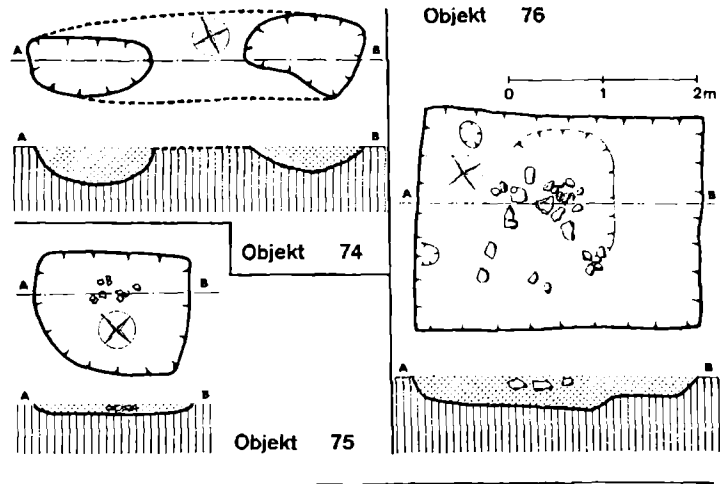

Objekt 75

Objekt 76

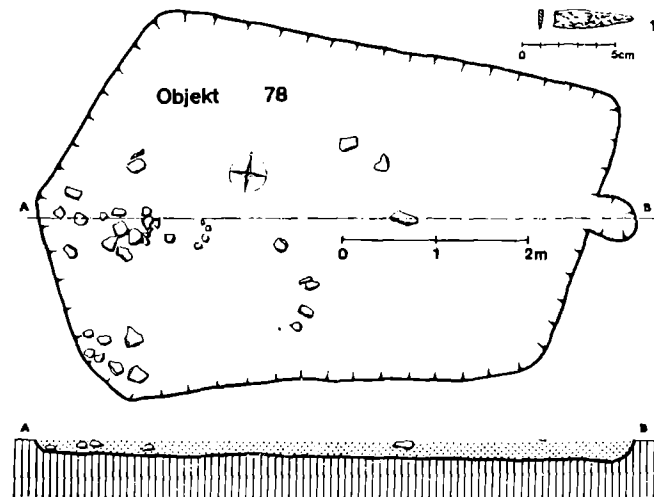

Tab. 34. Obj. 74; obj. 75; obj. 76; obj. 78: 1—133904.

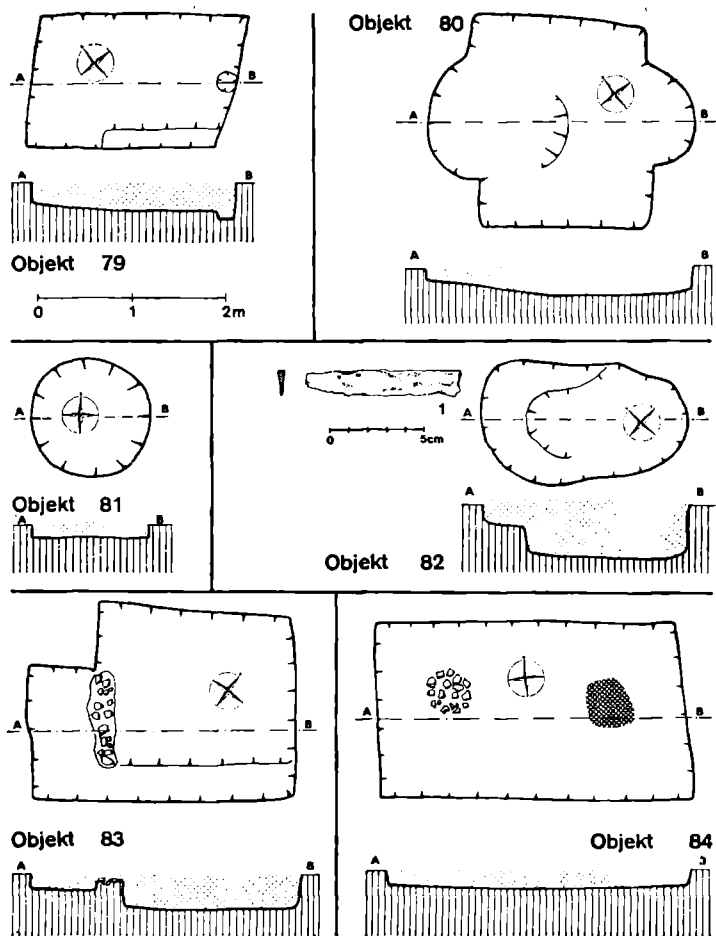
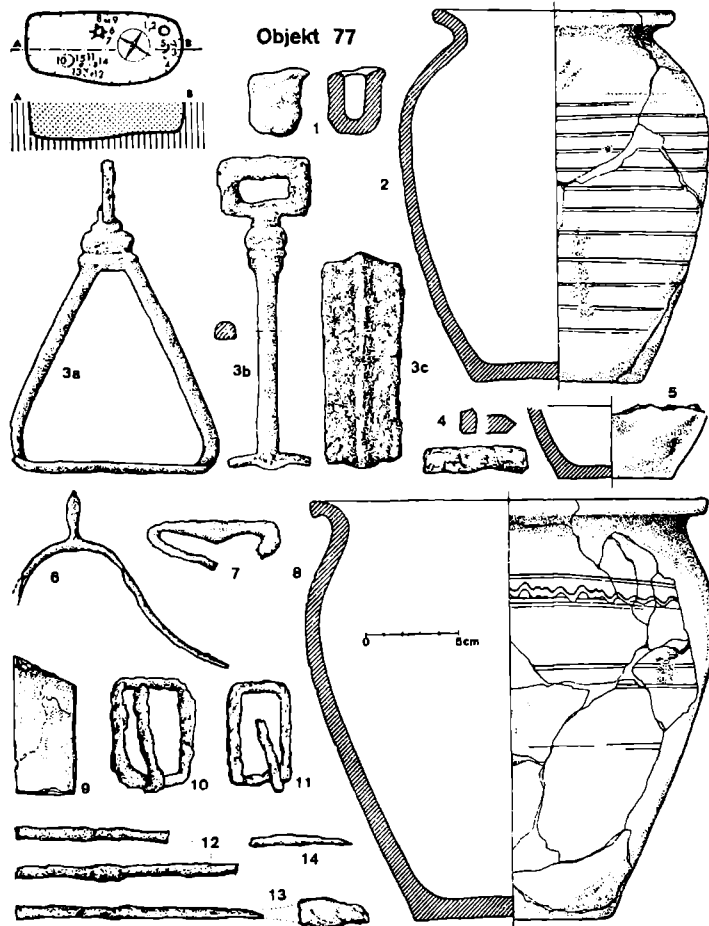

Tab. 35. Obj. 77: 1-133886, 2-132863, 3a,b,c-133875-6, 4-133879, 5-133862, 6-133880, 7-133881, 8-133864, 9-133865, 10-133883/1, 11-133883/2, 12-133877, 13-133882, 14-133878.

Tab. 36. Obj. 79; obj. 80; obj. 81; obj. 82: 1-134165; obj. 83; obj. 84.

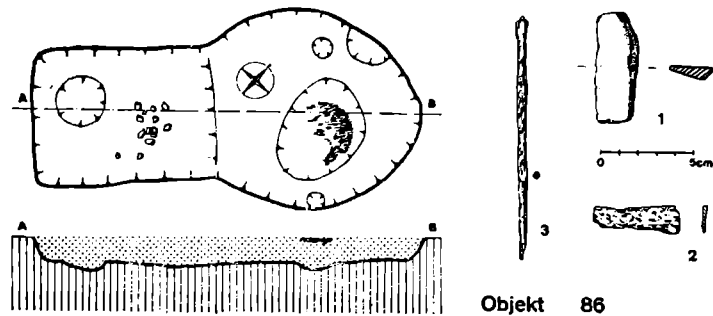

Objekt 86

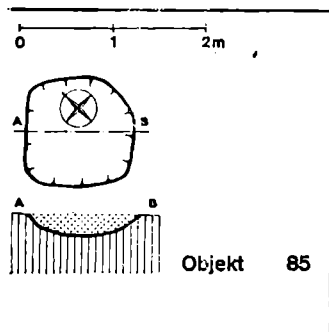

Objekt 85



Objekt 87

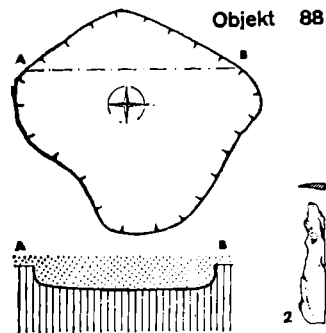
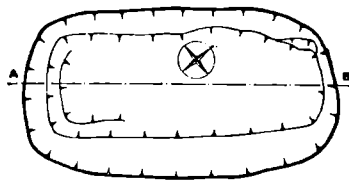
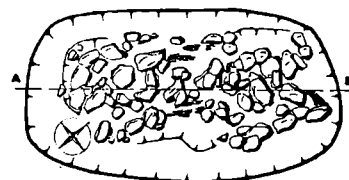

Objekt 88

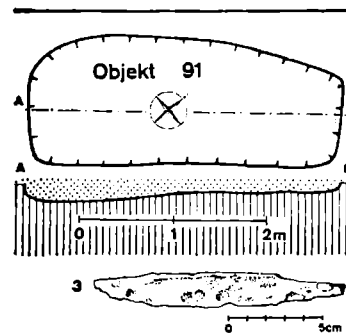

Objekt 91

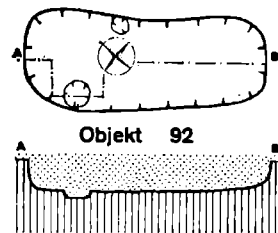

Objekt 92

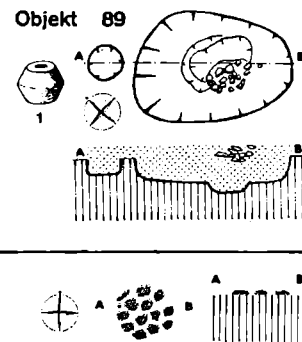

Objekt 89



Objekt 90

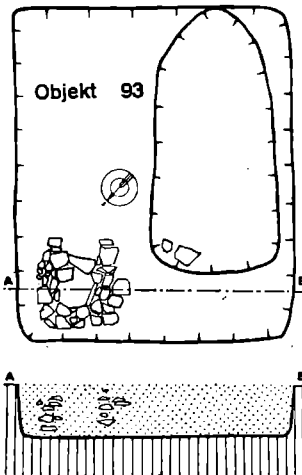

Objekt 93

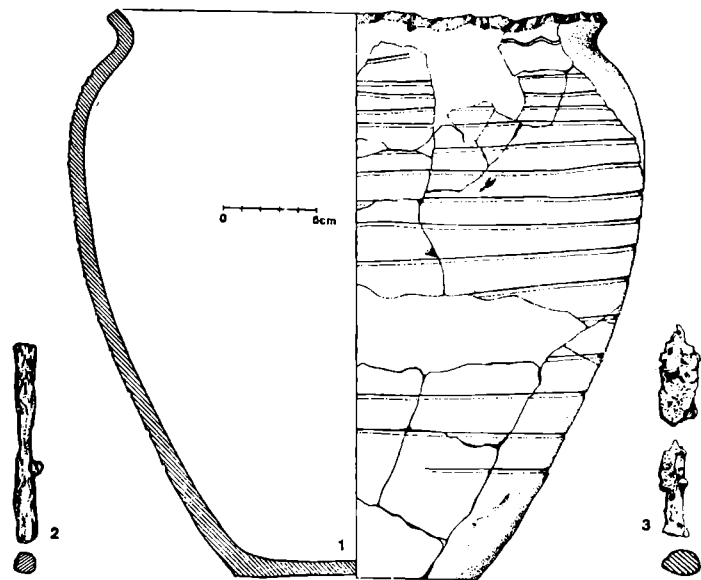

Objekt 93

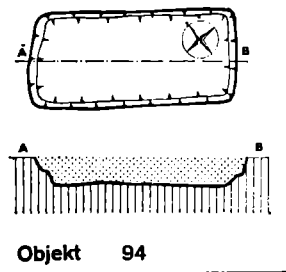
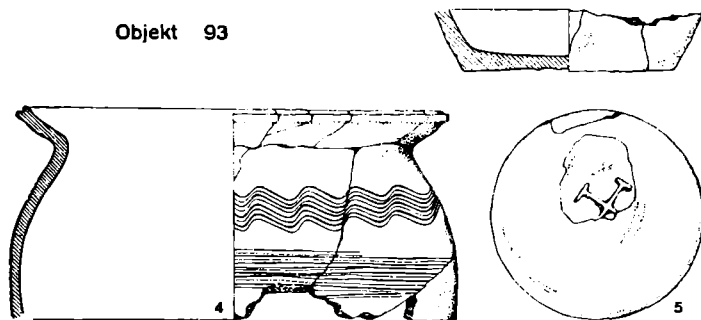

Objekt 94

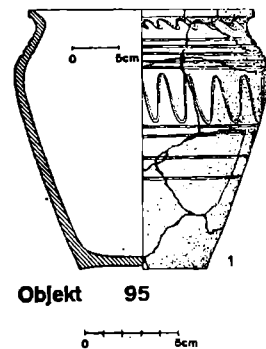

Objekt 95

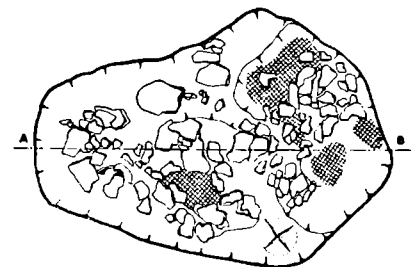
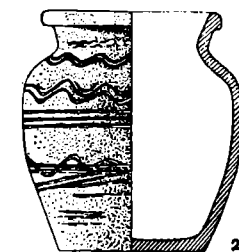

I. FÁZE

0 1 2m

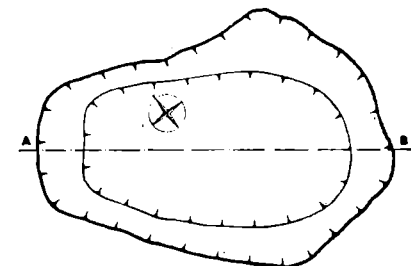

II. FÁZE

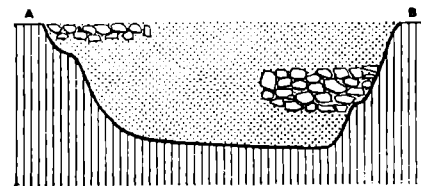

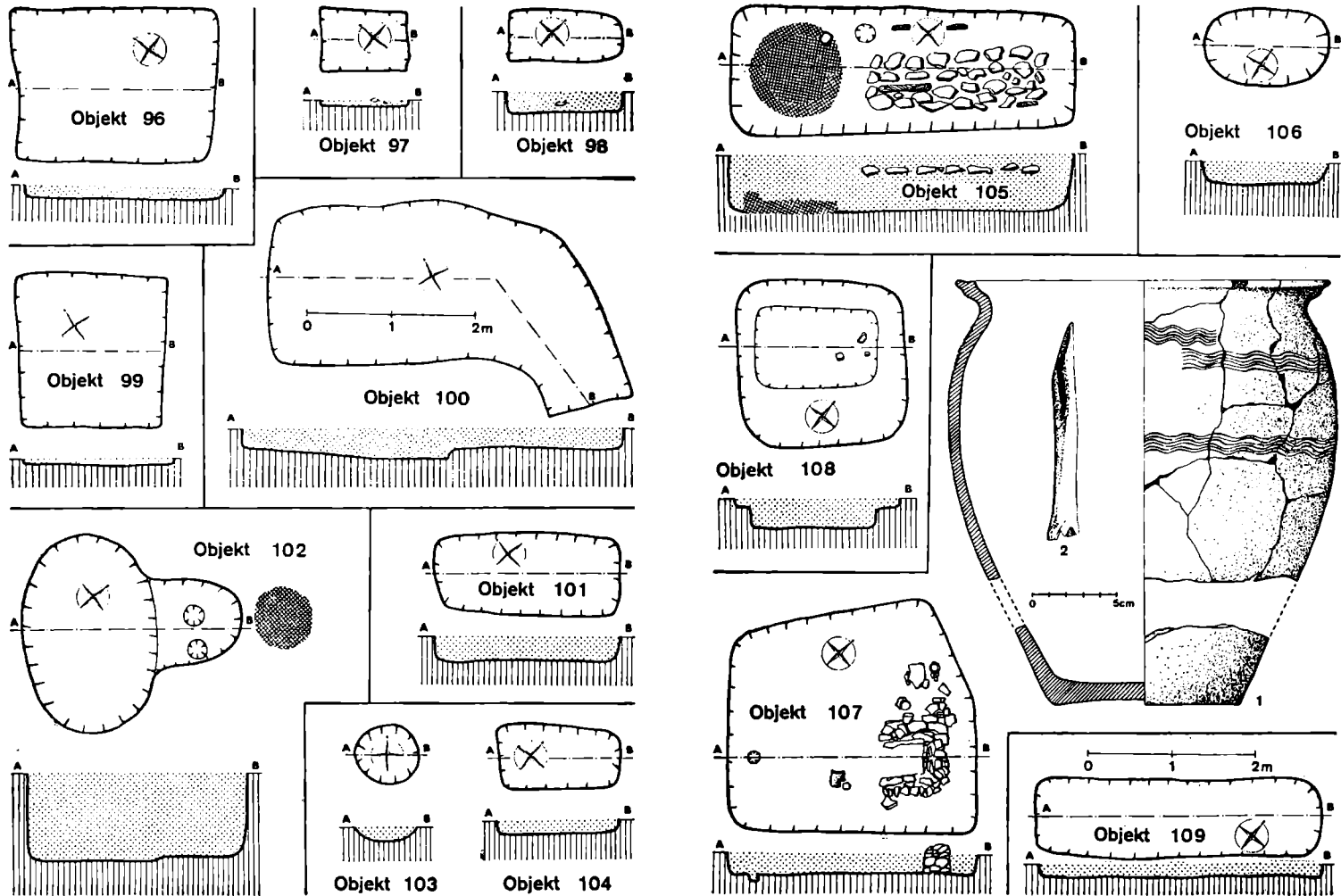

Tab. 41. Obj. 96; obj. 97; obj. 98; obj. 99; obj. 100; obj. 101; obj. 102; obj. 103; obj. 104.

Tab. 42. Obj. 105; obj. 106; obj. 107: 1—135336, 2—135044; obj. 108; obj. 109.

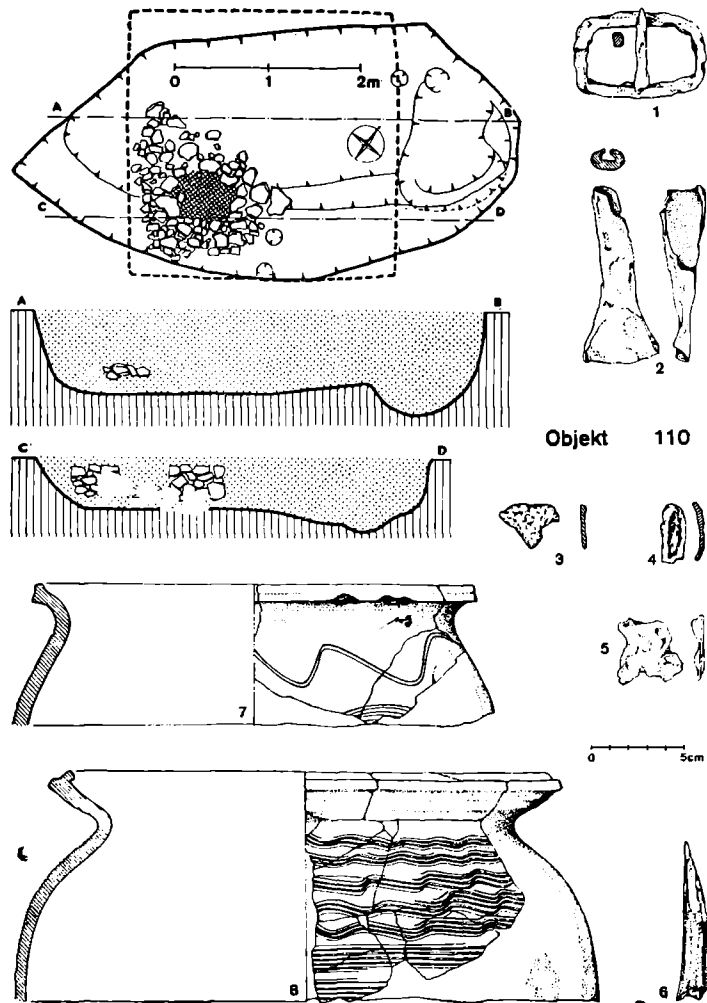

Tab. 43. Obj. 110: 1-136433, 2-136434, 3-136432/2, 4-136432/1, 5-136435, 6-136436, 7-135999, 8-135981.

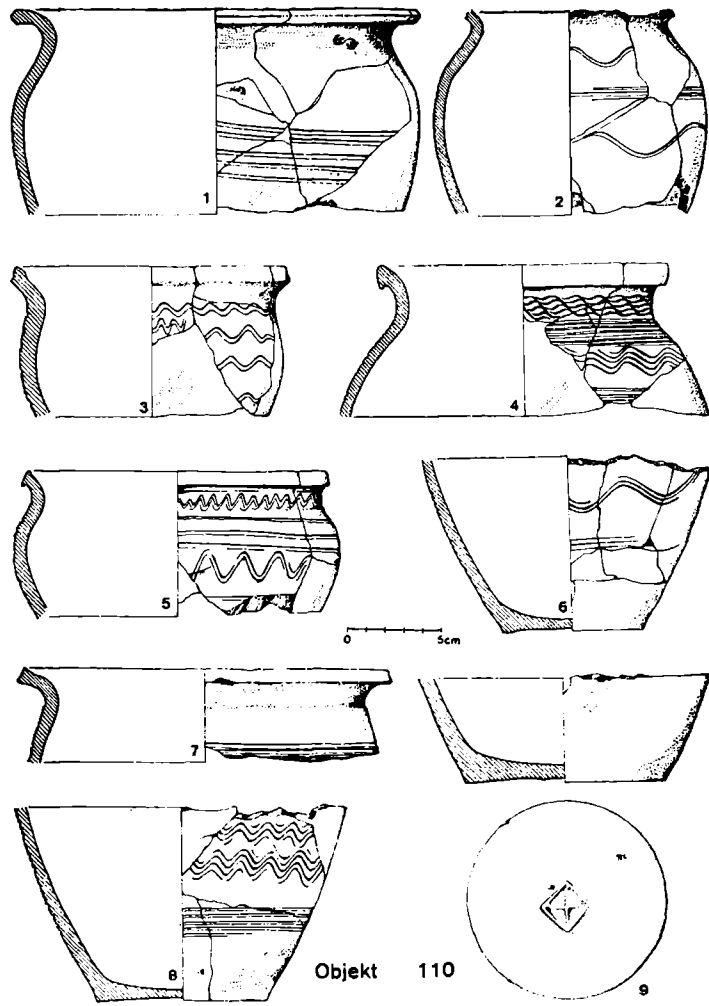

Tab. 44. Obj. 110: 1-135982, 2-135985, 3-135916, 4-135986, 5-135915, 6-135983, 7-136000, 8-135987, 9-135991.

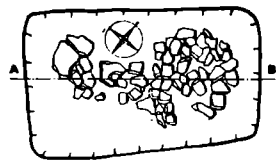

Objekt 111

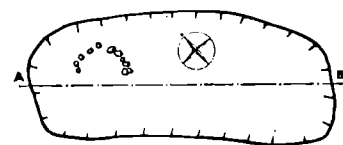
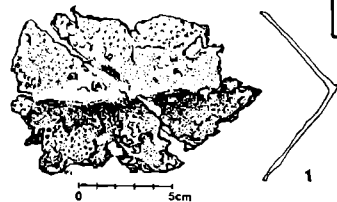

Objekt 114

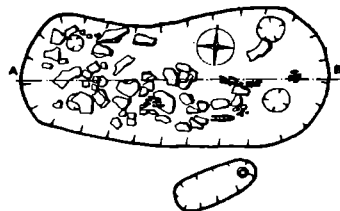

Objekt 112

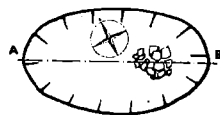
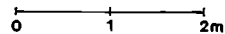
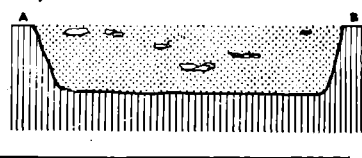

Objekt 113



Objekt 115

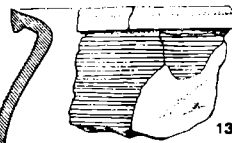
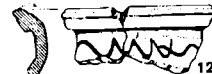
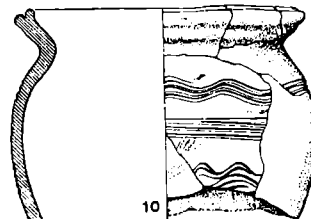
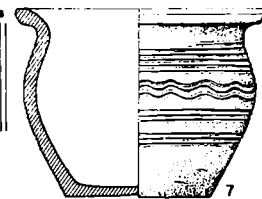
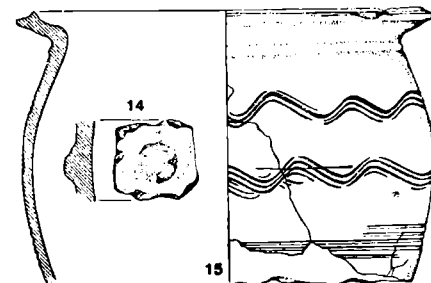
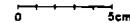
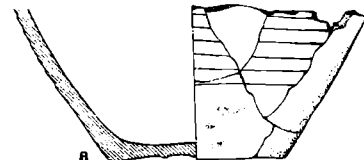
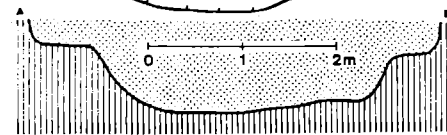
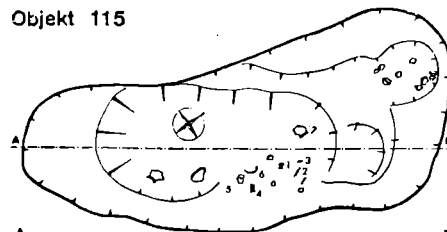

Tab. 46. Obj. 115: 1-137160, 2-137161, 3-137165/2, 4-137164, 5-137162-3, 6-137165/1, 7-136615, 8-136620, 9-136626, 10-136616, 11-136625, 12-136627, 13-136610, 14-136654, 15-136618.

Tab. 45. Obj. 111; obj. 112; obj. 113; obj. 114: 1-136613.

Objekt 119

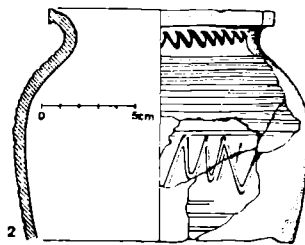
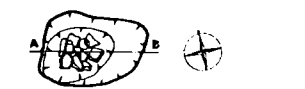
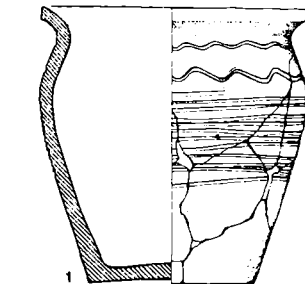
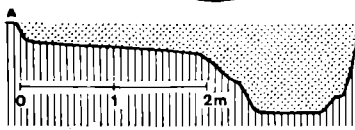
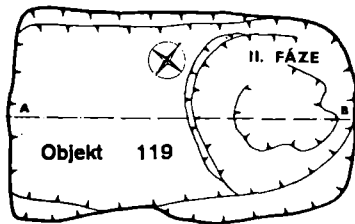
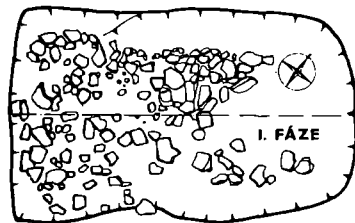
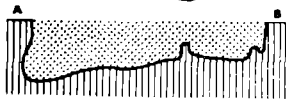
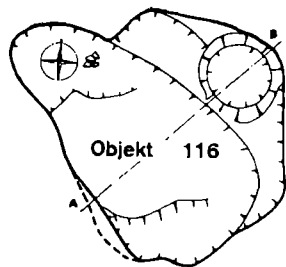
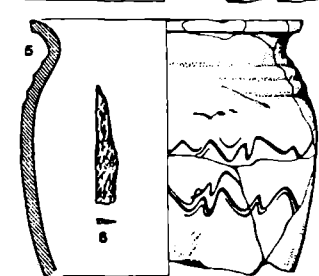
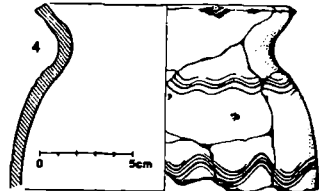
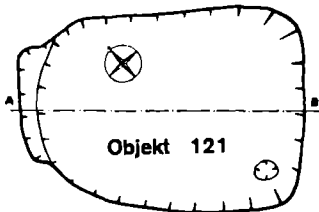
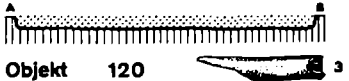
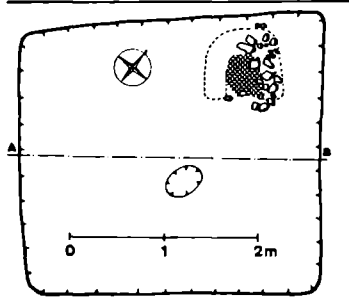
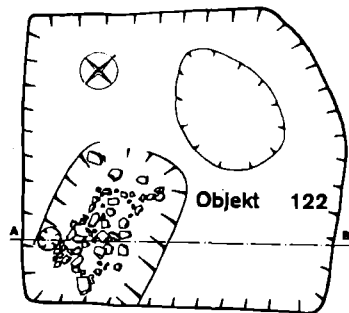
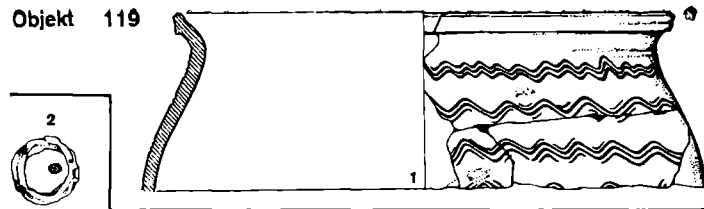

Tab. 48. Obj. 119: 1-137312; obj. 120: 3-137523; obj. 121: 4-137592, 5-137524, 6-137714; obj. 122: 2-137934.

Tab. 47. Obj. 116: obj. 117; obj. 119: 1-137262; obj. 119 2-137311.

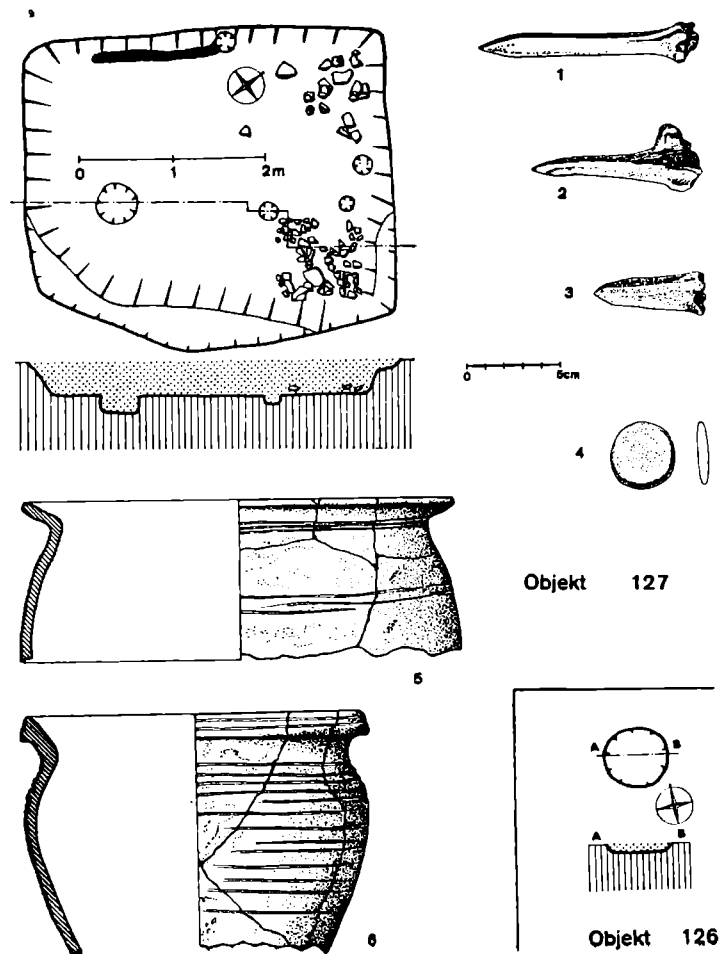
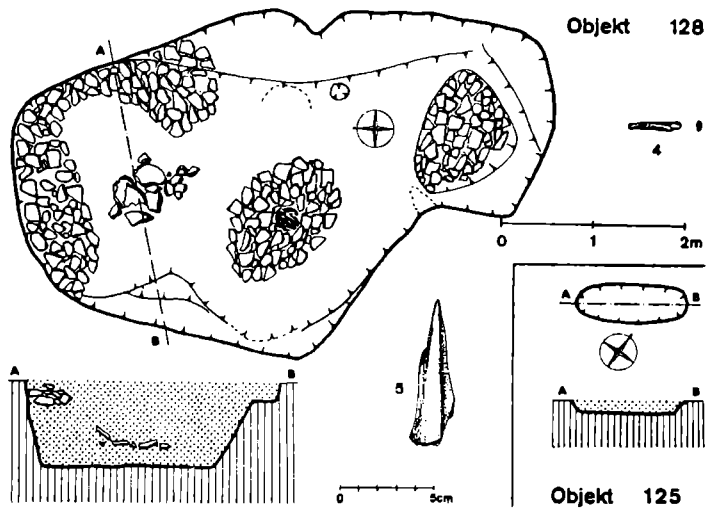
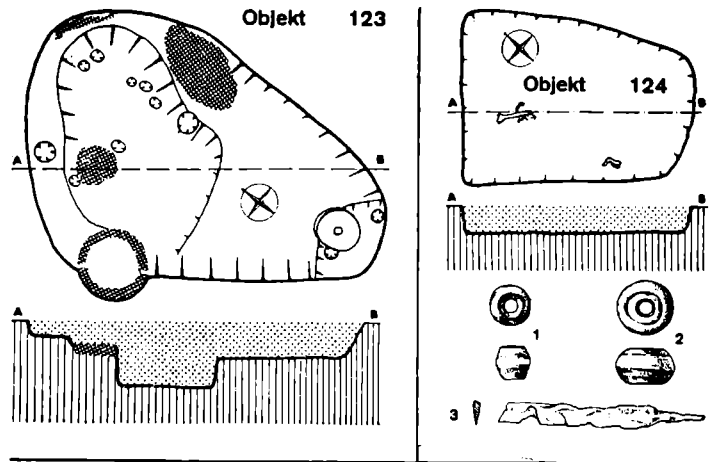

Tab. 49. Obj. 123: 1-138234, 2-138233, 3-138230; obj. 125; obj. 128: 4-139805, 5-139806.

Tab. 50. Obj. 126; obj. 127: 1-139349, 3-139350, 3-139351, 4-139352, 5-138360, 6-138359.

Objekt 129

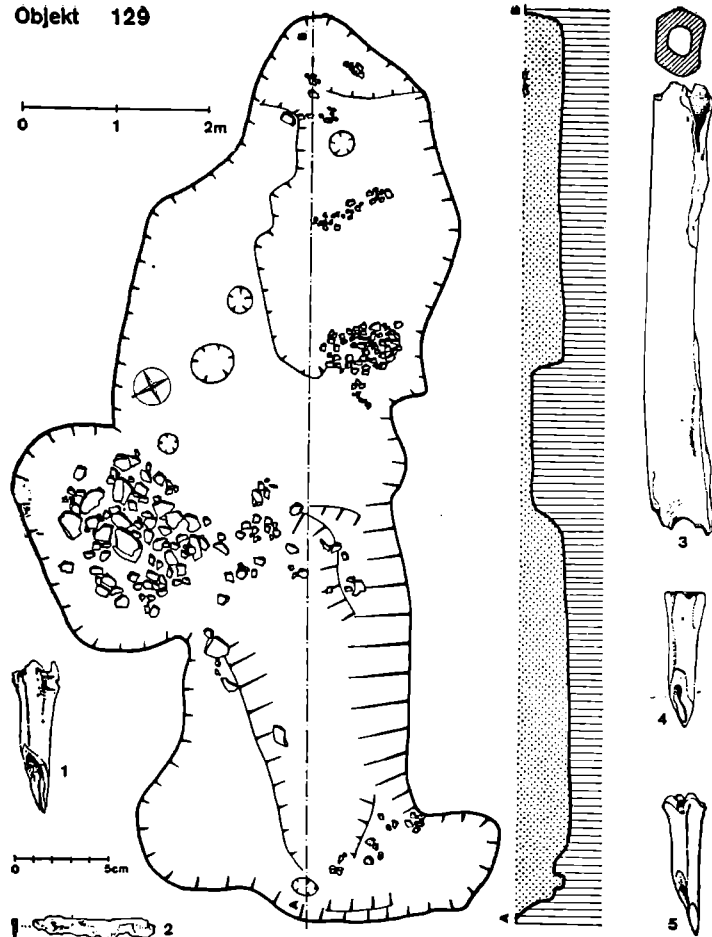

Tab. 51. Obj. 129: 1-140266, 2-140264, 3-140265, 4-140267, 5-140268.

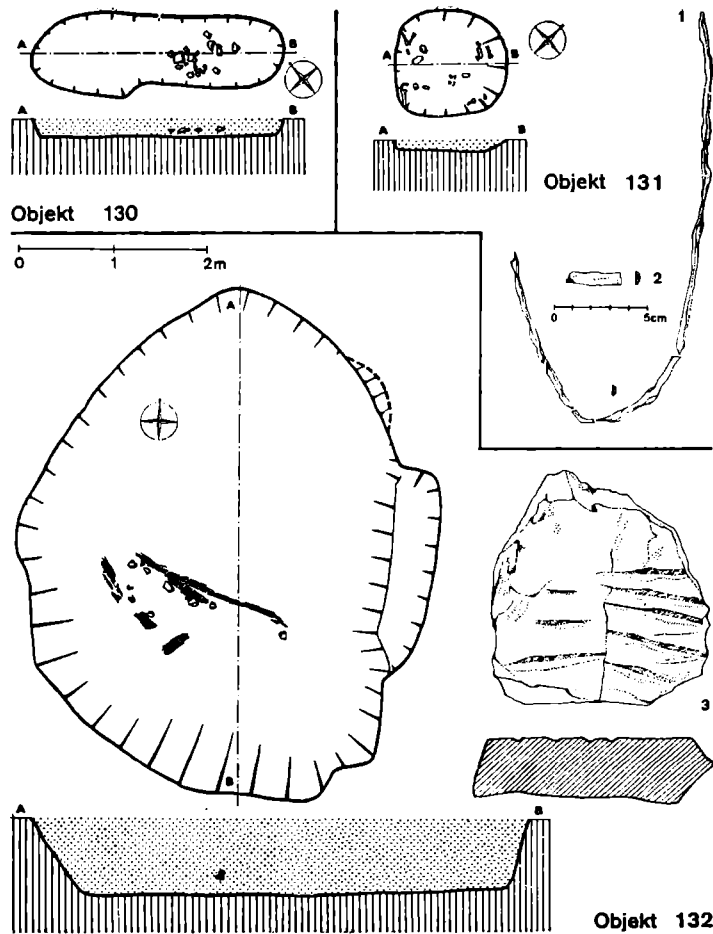

Tab. 52. Obj. 130; obj. 131: 1-140387/1-3, 2-140387/4-5; obj. 132: 3-140471.

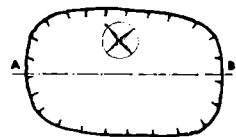

Objekt 133

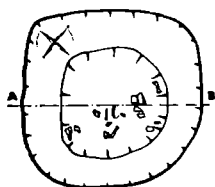

Objekt 135

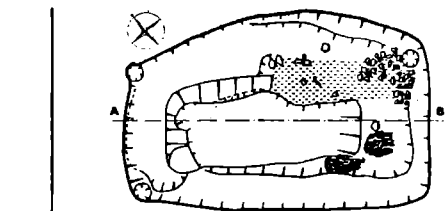
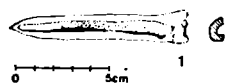

Objekt 134

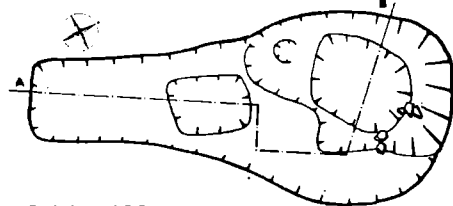
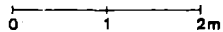
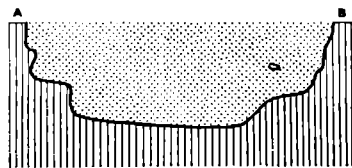

Objekt 136

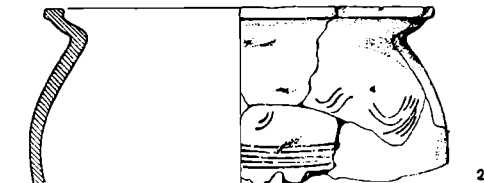
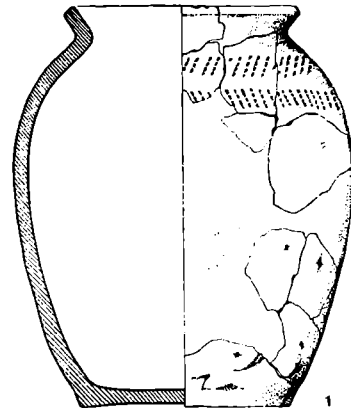

Objekt 136

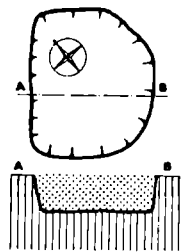

Objekt 138

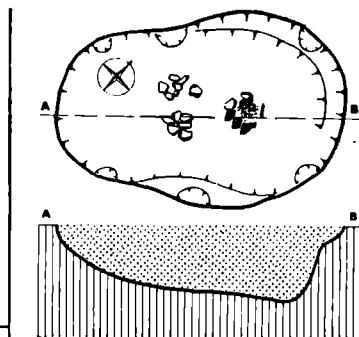

Objekt 137

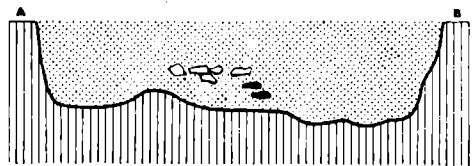
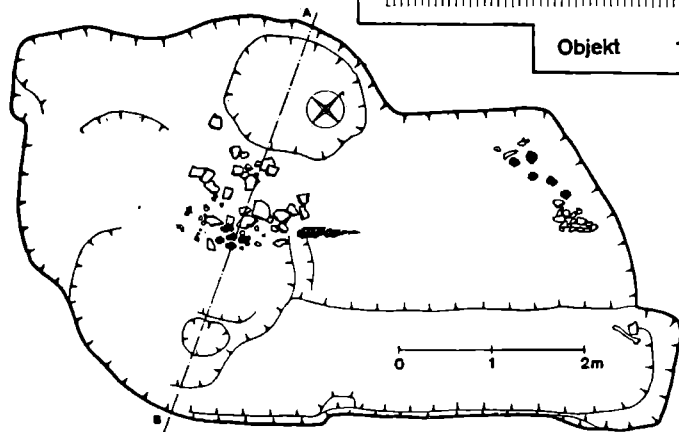

Objekt 139

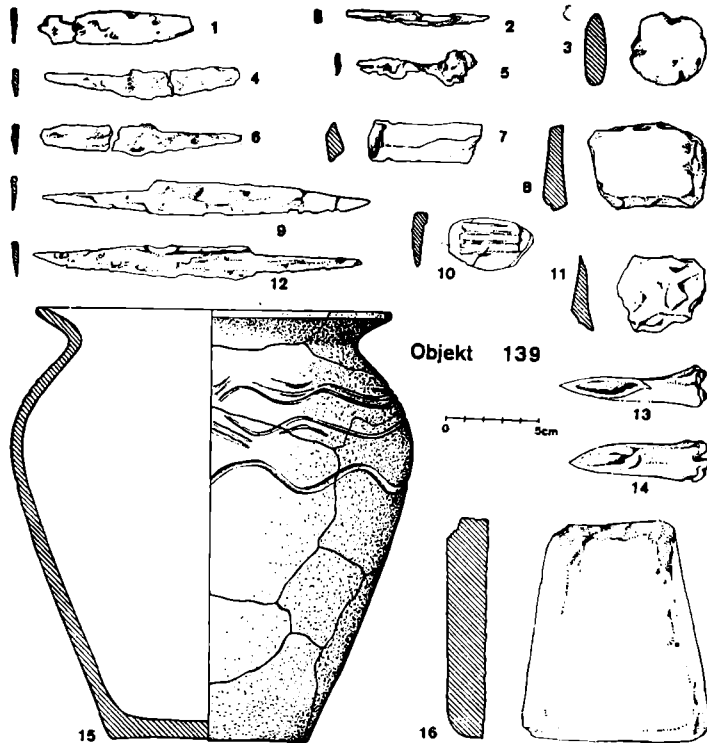

Objekt 139

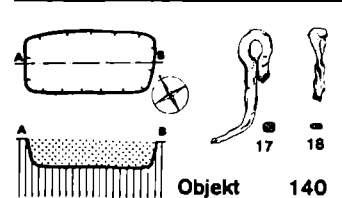

Objekt 140

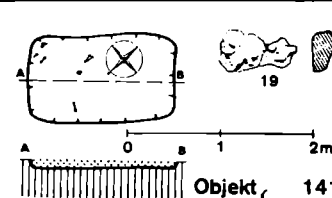

Objekt, 141

Tab. 56. Obj. 139: 1-142731, 2-142733/3, 3-142734, 4-142733/1,2, 5-142729
 6-142732/2-3, 7-142741, 8-142740, 9-142732/1, 10-142739, 11-142736, 12-142730,
 13-142738, 14-142735, 15-141294, 16-142737; obj. 140: 17-142750/1, 18-142750/2; obj.
 141: 19-142765.

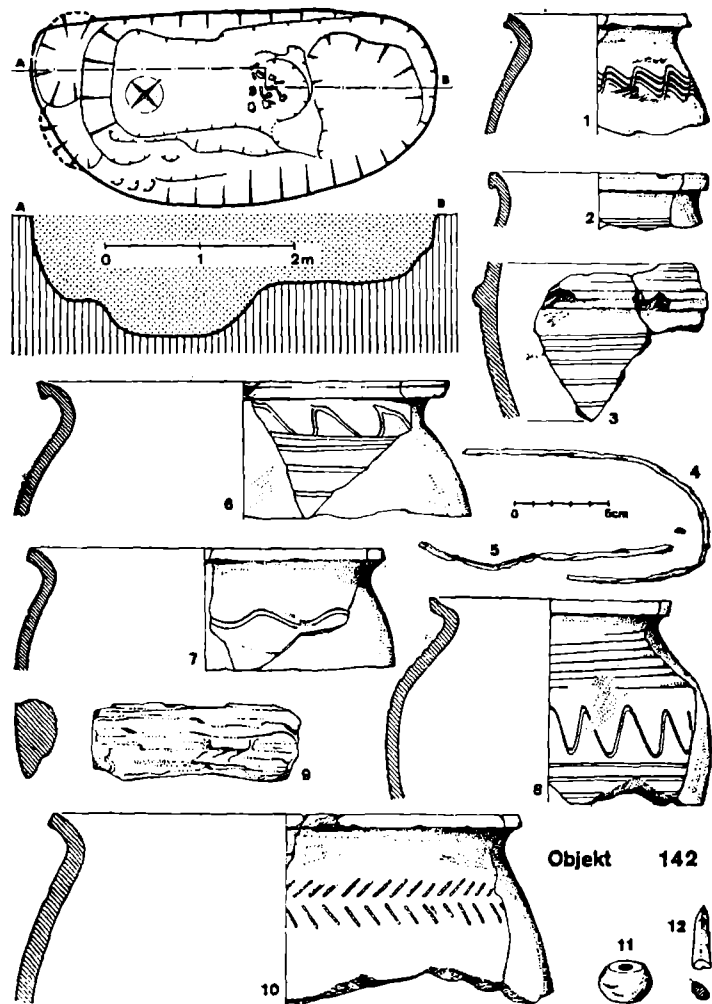

Tab. 57. Obj. 142: 1-142769, 2-142781, 3-142767, 4,5-143193/1-2, 6-142771, 7-142777, 8-142768, 9-143194, 10-142766, 11-143195, 12-143196.

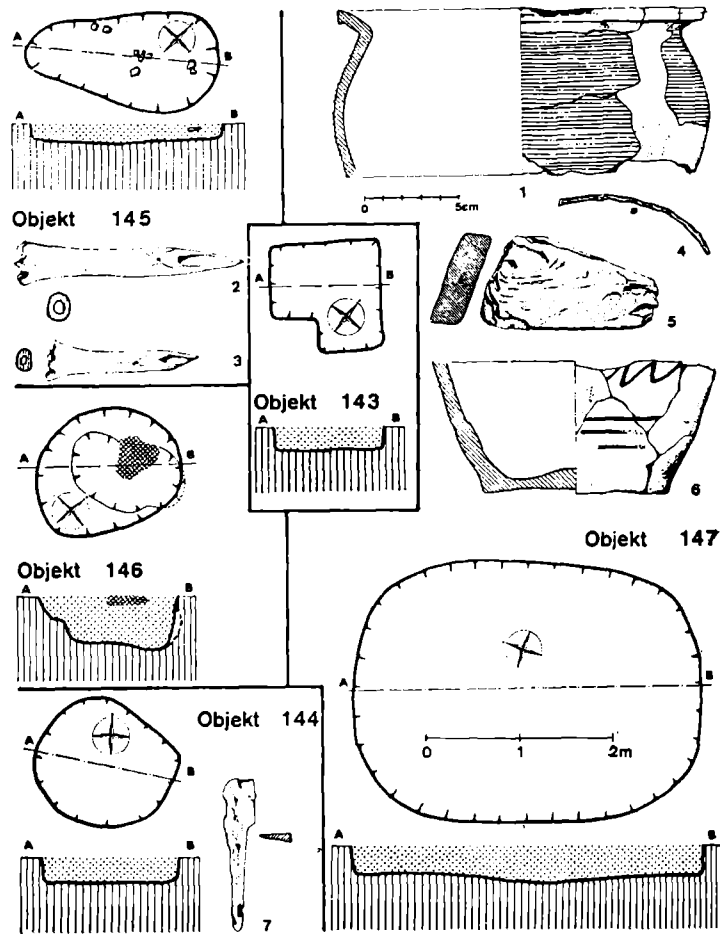

Tab. 58. Obj. 143; obj. 144: 7-143232; obj. 145: 2-143441, 3-143440; obj. 146; obj. 147: 1-152343, 4-152426, 5-152427, 6-152344.

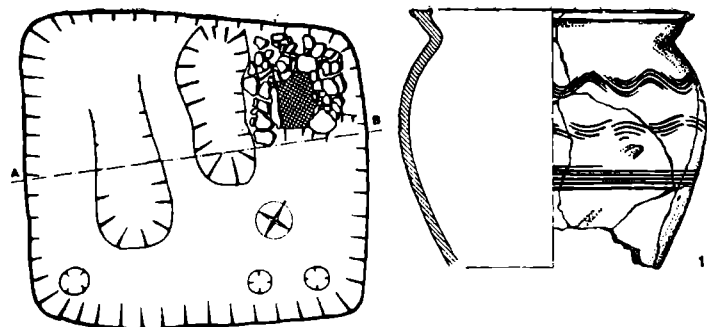

Objekt 148

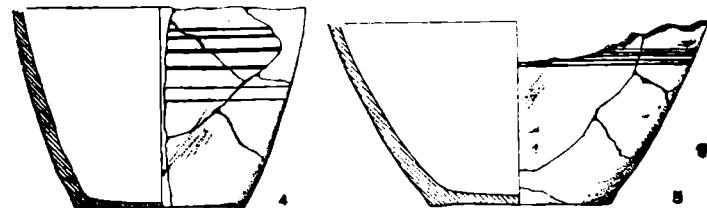
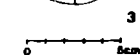
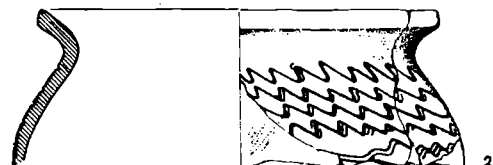
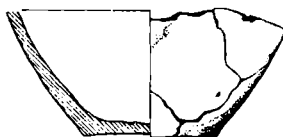
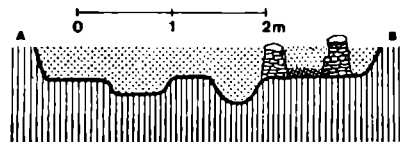

Tab. 59. Obj. 148: 1—152429, 2—152431, 3—152477, 4—152477, 5—152432.

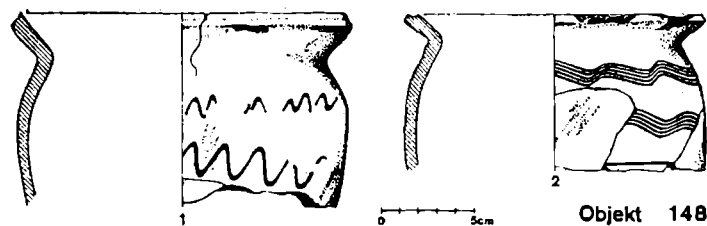

Objekt 148

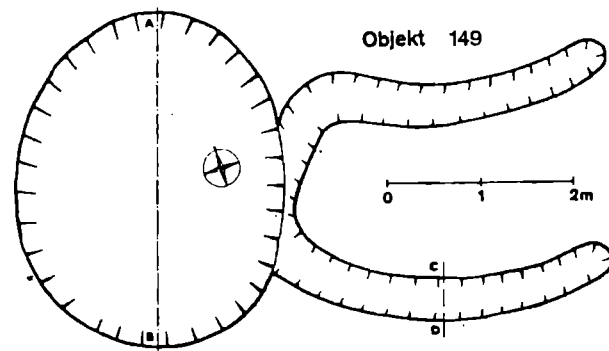

Objekt 149

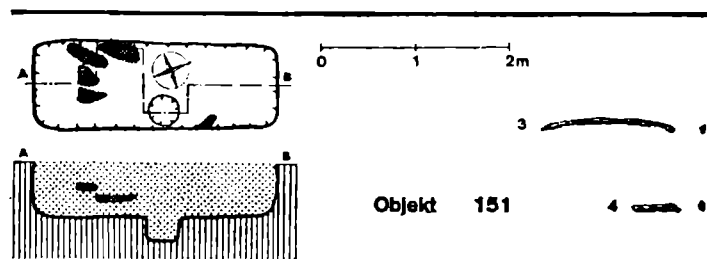

Objekt 151

Tab. 60. Obj. 148: 1—152428, 2—152430; obj. 149; obj. 151: 3, 4—152600/1, 2.

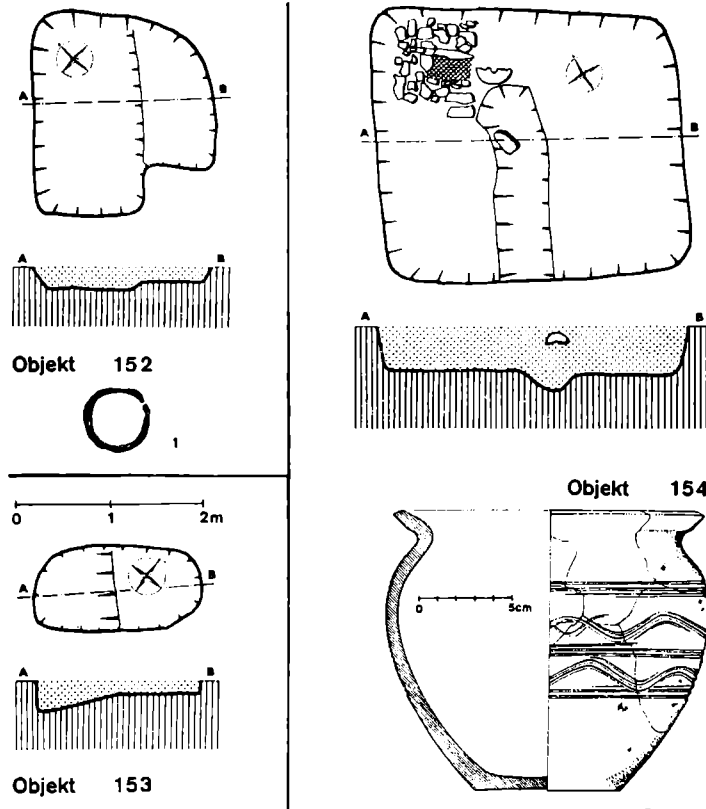
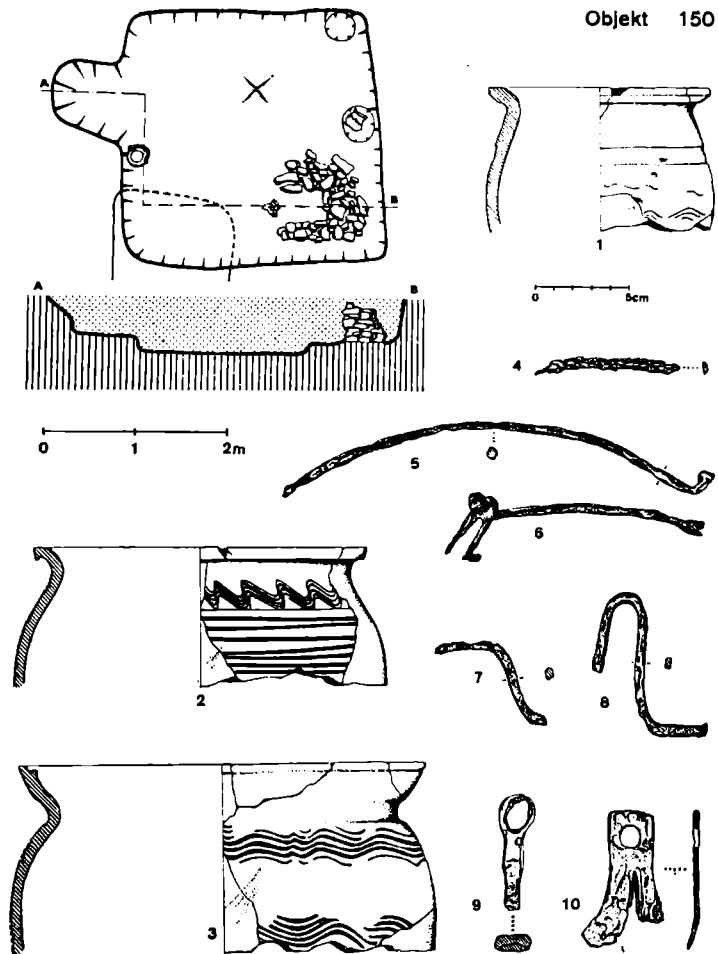

Tab. 61. Obj. 150: 1-152546, 2-152545, 3-152543, 4-152609, 5,6-152608, 7-152611/3, 8-152611/2, 9-152610, 10-152611/1.

Tab. 62. Obj. 152: 1-152702; obj. 153; obj. 154: 2-168231.

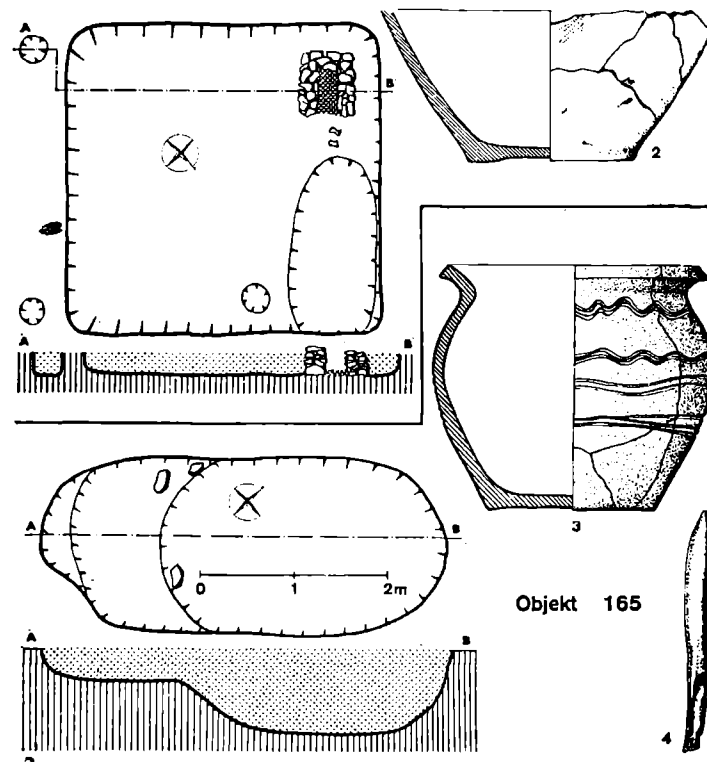
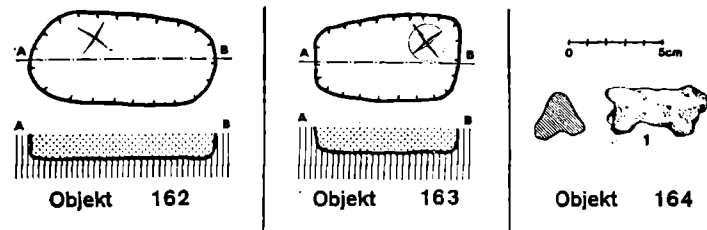
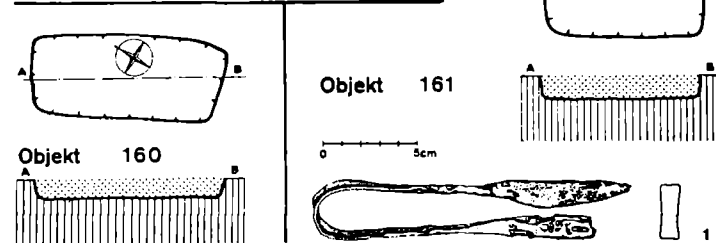
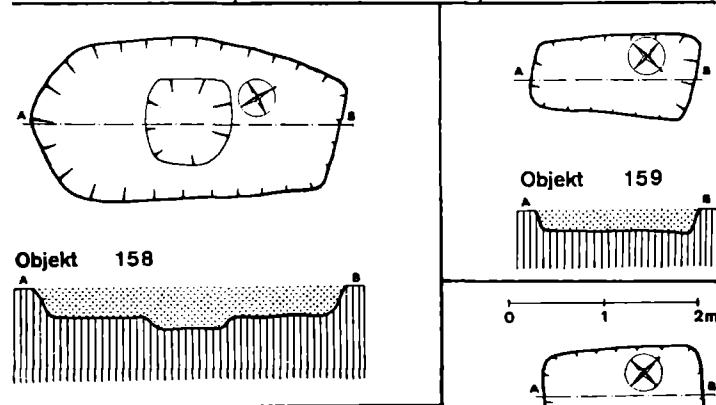
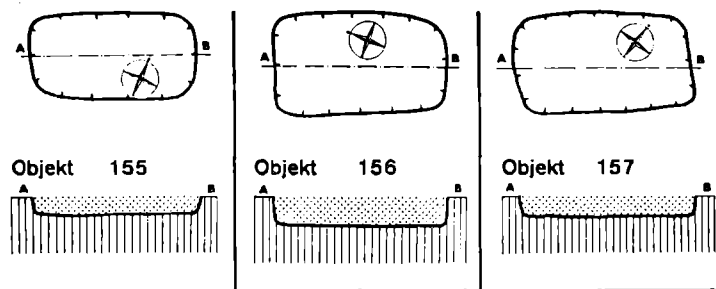

Tab. 63. Obj. 155; obj. 156; obj. 157; obj. 158; obj. 159; obj. 160; obj. 161:

1-159249

Tab. 64. Obj. 162; obj. 163; obj. 164: 1-161070, 2-161065; obj. 165: 3-152889, 4-153264.

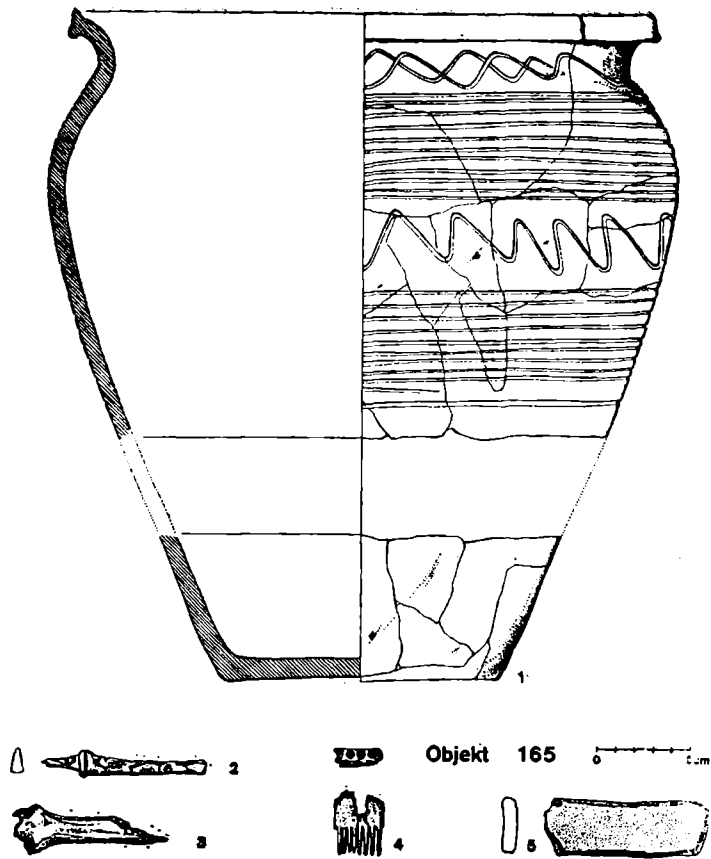

Tab. 65. Obj. 165: 1-152662, 2-153261, 3-153263, 4-153262, 5-153265.

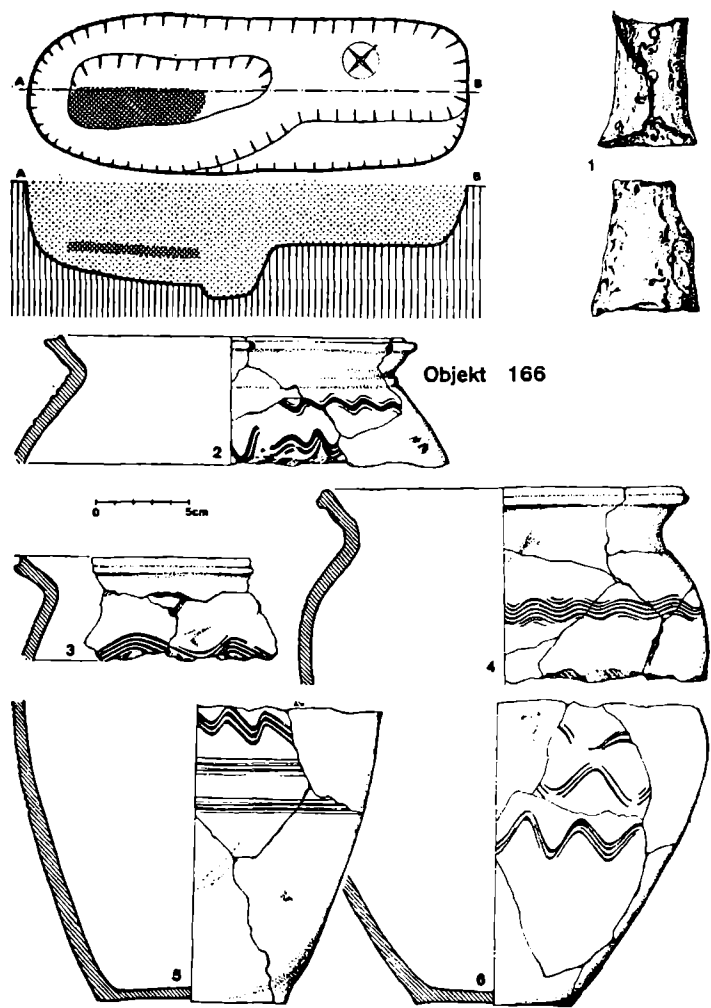

Tab. 66. Obj. 166: 1-153549, 2-153268, 3-153269, 4-153264, 5-153207, 6-159208.

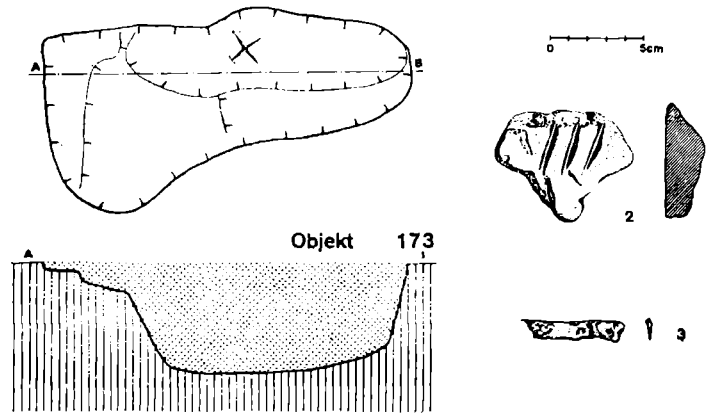
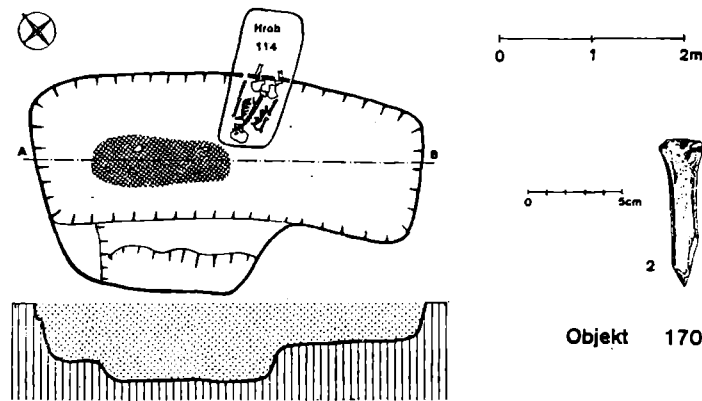
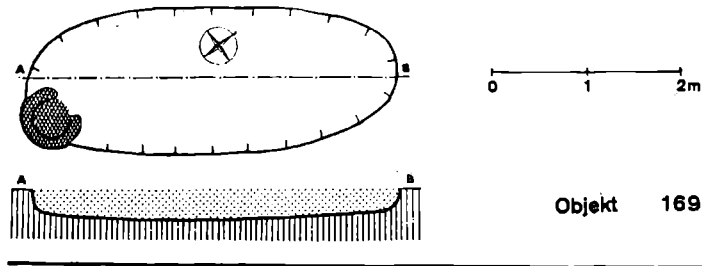
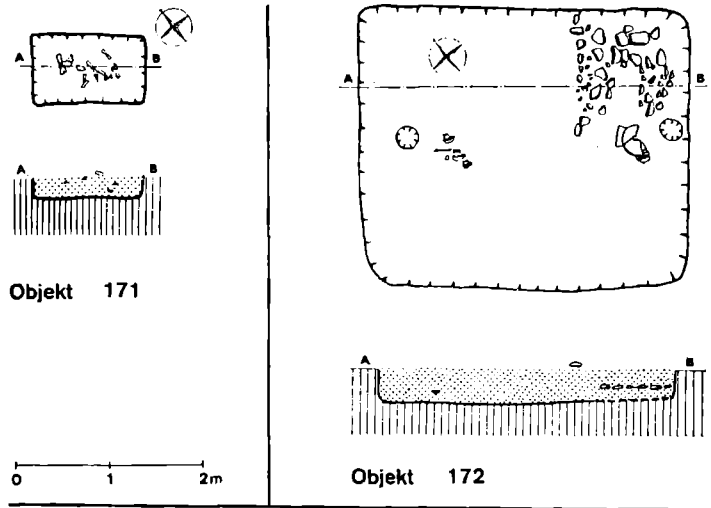
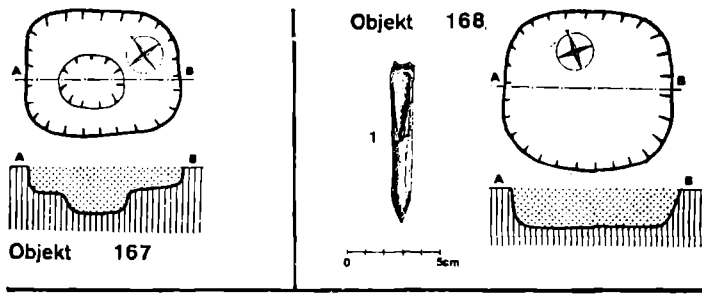

Tab. 67. Obj. 167; obj. 168: 1—153636; obj. 169; obj. 170: 2—154604.

Tab. 68. Obj. 171; obj. 172; obj. 173: 2—154987, 3—154986.

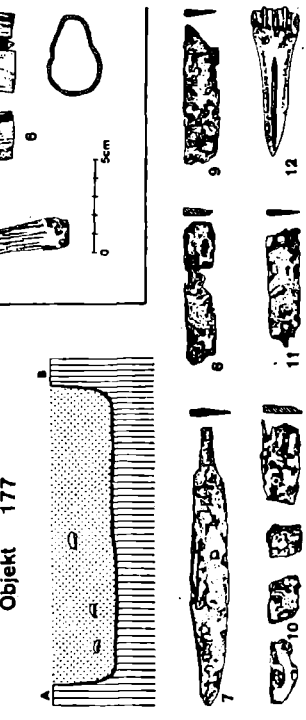
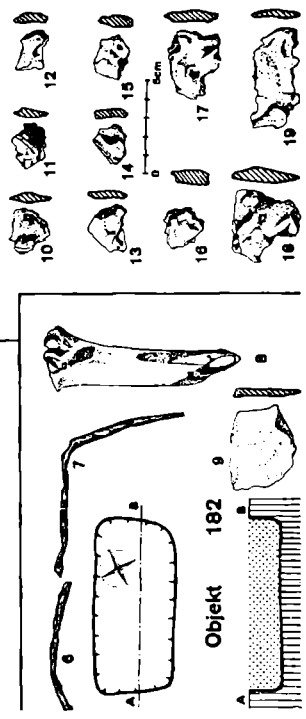
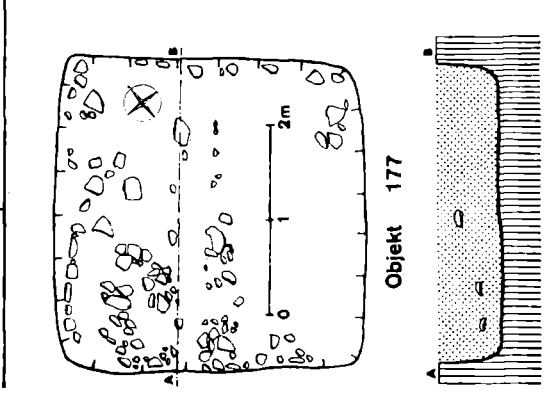
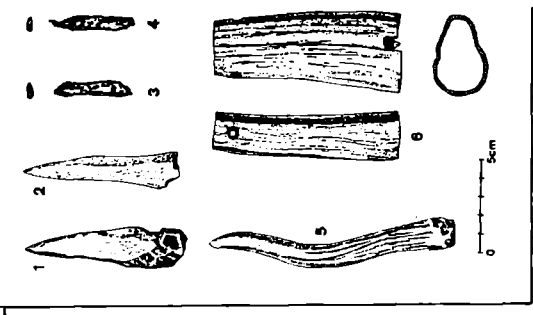
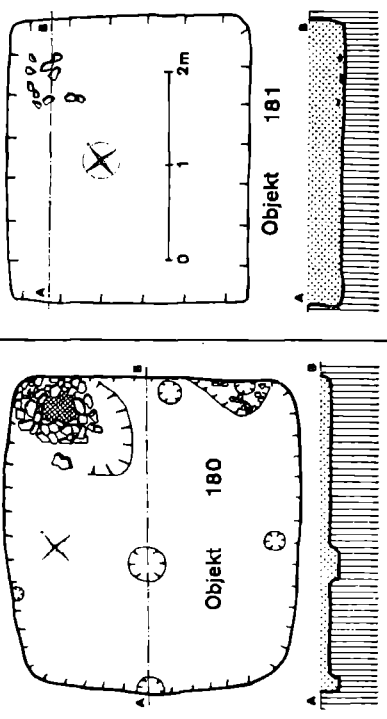
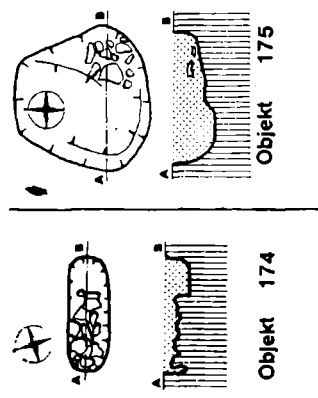
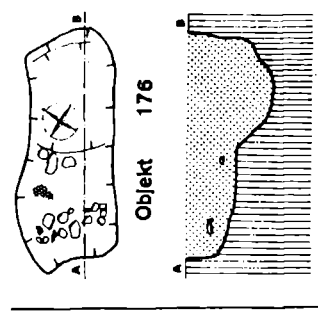
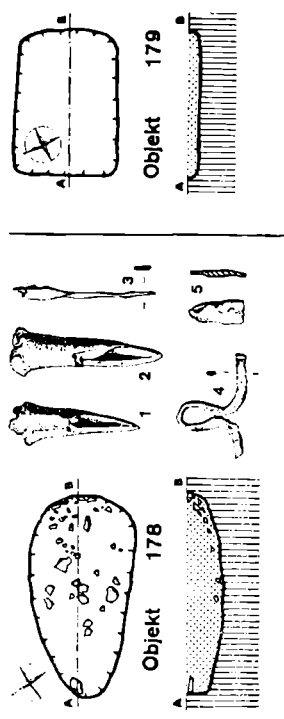

Tab. 70. Obj. 178: 1-135637, 2-135626, 3-135624/2, 4-135624/1, 5-135625; Obj. 179: 5-135147, 6-135150; Obj. 177: 7-135448, 8-135440/1, 9-135440/2, 10-135440/3-6, 11-135450, 12-135451.

Tab. 69. Obj. 174; Obj. 175; Obj. 176: 1-135146/1, 2-135146/2, 3-135148, 4-135149, 5-135147, 6-135150; Obj. 177: 7-135448, 8-135440/1, 9-135440/2, 10-135440/3-6, 11-135450, 12-135451.

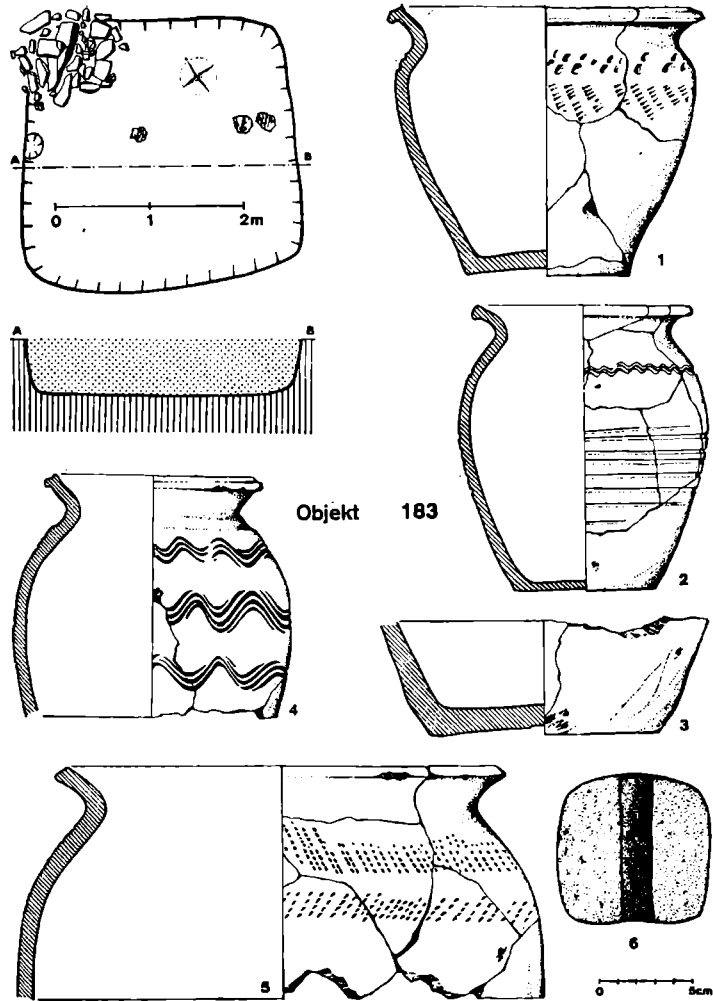

Tab. 71. Obj. 183: 1-155717, 2-155718, 3-155720/1, 4-155719, 5-158720/2, 6-155812.

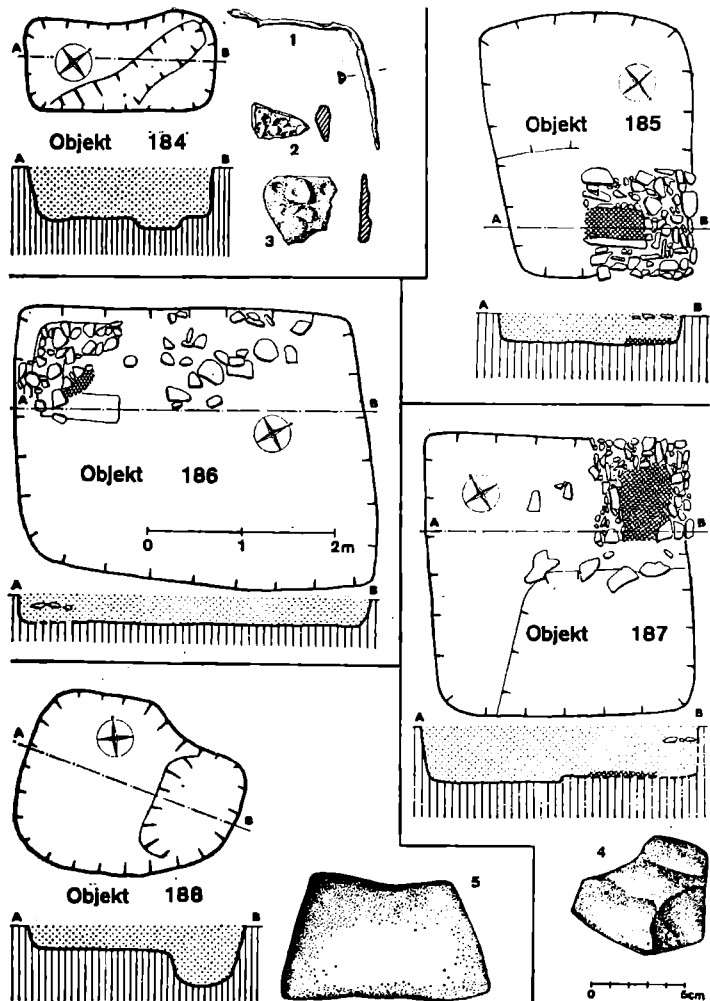

Tab. 72. Obj. 184: 1-3-155056; obj. 185; obj. 186; obj. 187: 4-155980; obj. 188: 5-155981.

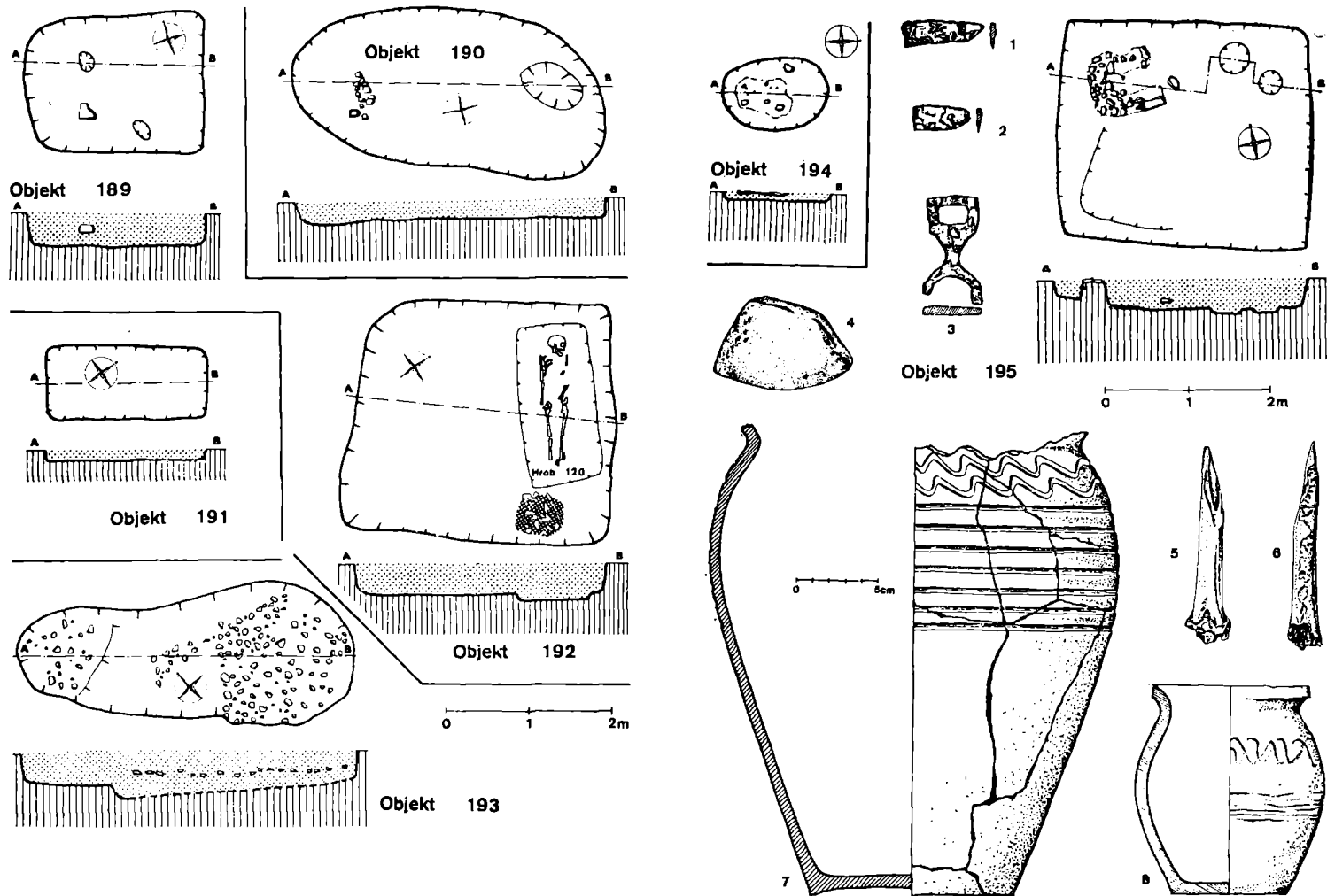

Tab. 73. Obj. 189; obj. 190; obj. 191; obj. 192; obj. 193.

Tab. 74. Obj. 194; obj. 195: 1, 2—156243/1-2, 3—156247, 4—156251, 5—156240, 6—156250, 7—156223, 8—156225.

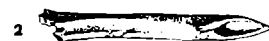
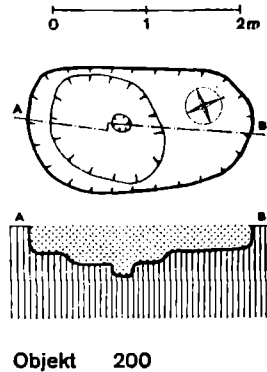
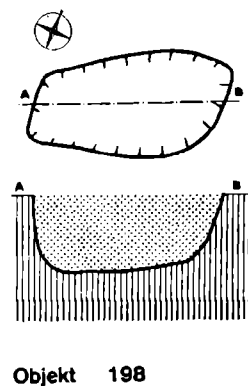
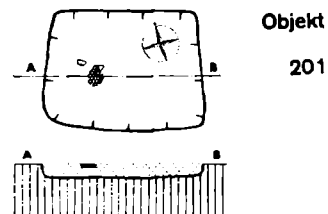
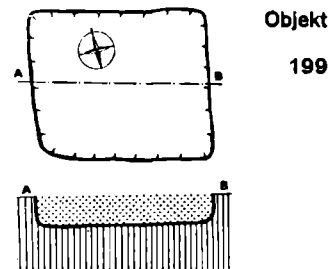
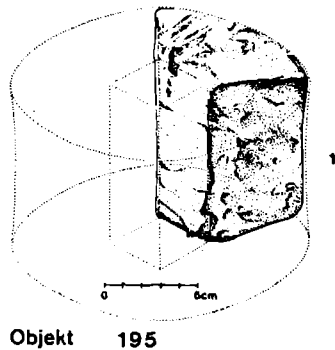
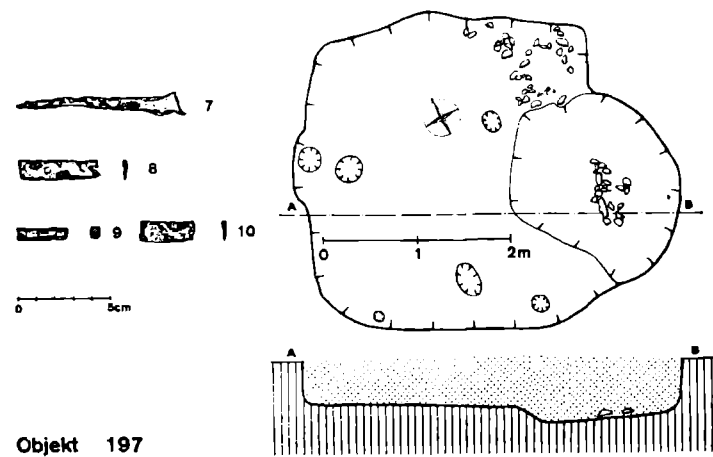
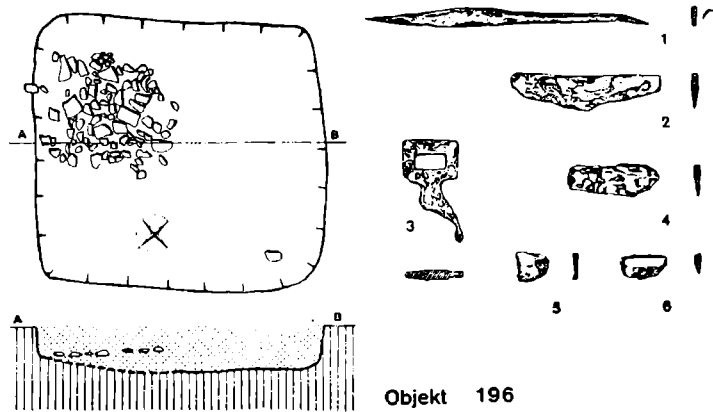

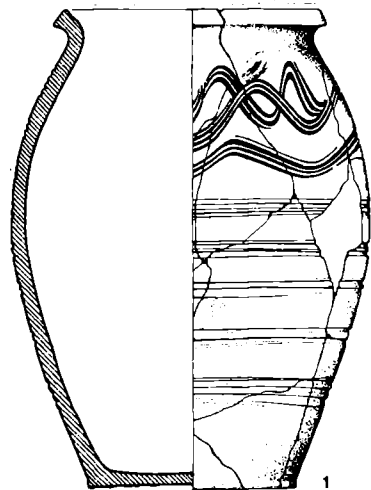
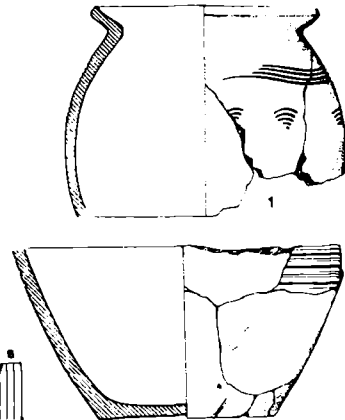
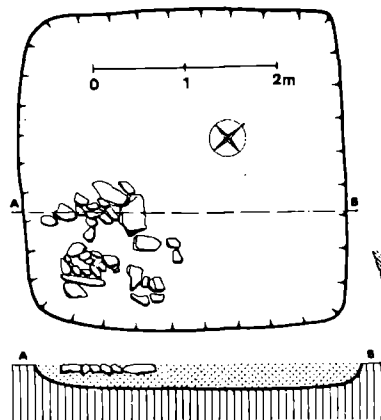
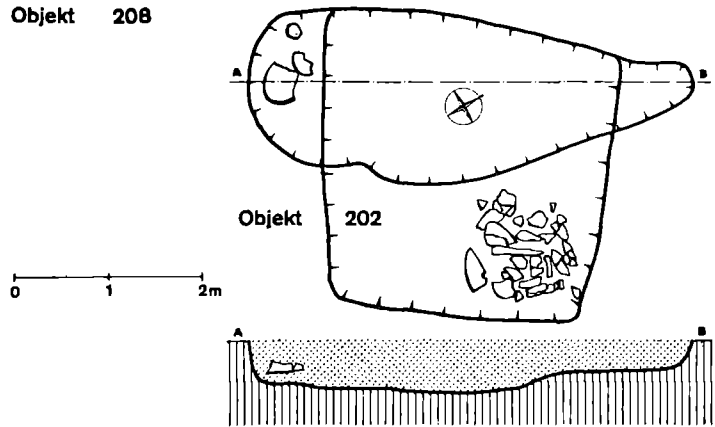

Objekt 202

0 5cm

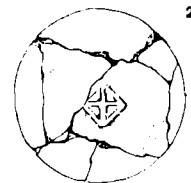
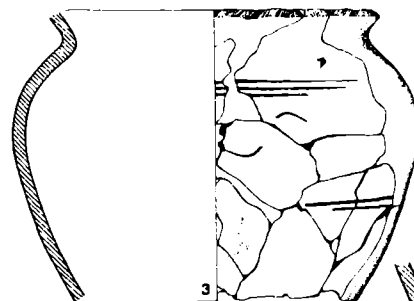
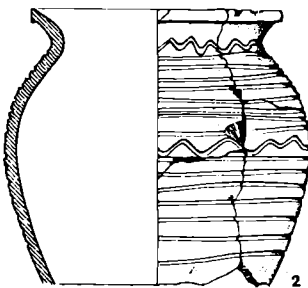

Objekt 203



0 5cm

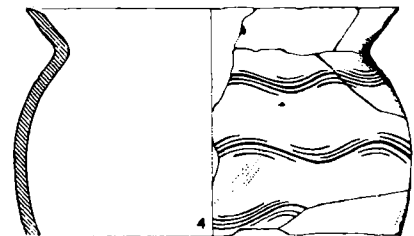

Tab. 77. Obj. 202: 1-156568, 2-156567.

Tab. 78. Obj. 203: 1-159211, 2-156721, 3-159210, 4-159215, 5-159213, 6-156733/2, 7-156733.1.

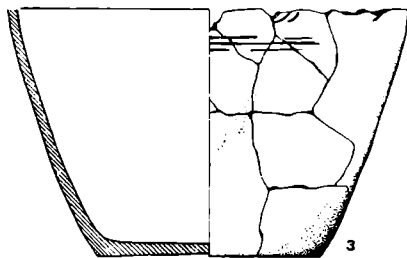
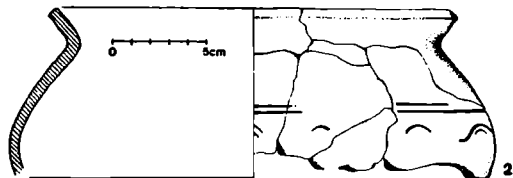
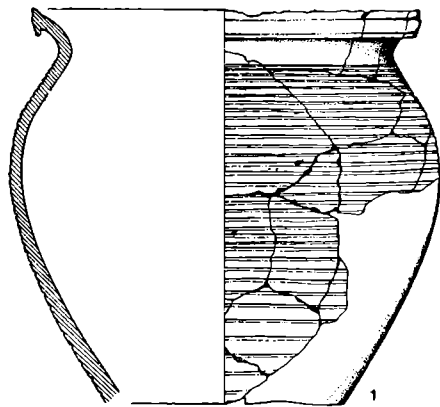

Objekt 203

Tab. 79. Obj. 203: 1—159209, 2—159212, 3—159214.

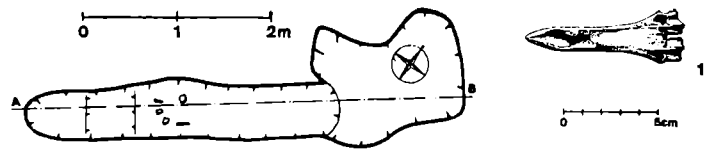

Objekt 204

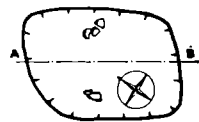

Objekt 206

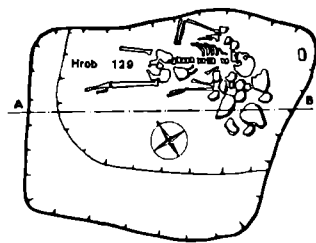

Objekt 205

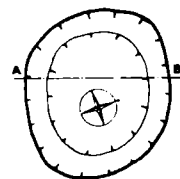

Objekt 207



Tab. 80. Obj. 204: 1—156774; obj. 205; obj. 206; obj. 207.

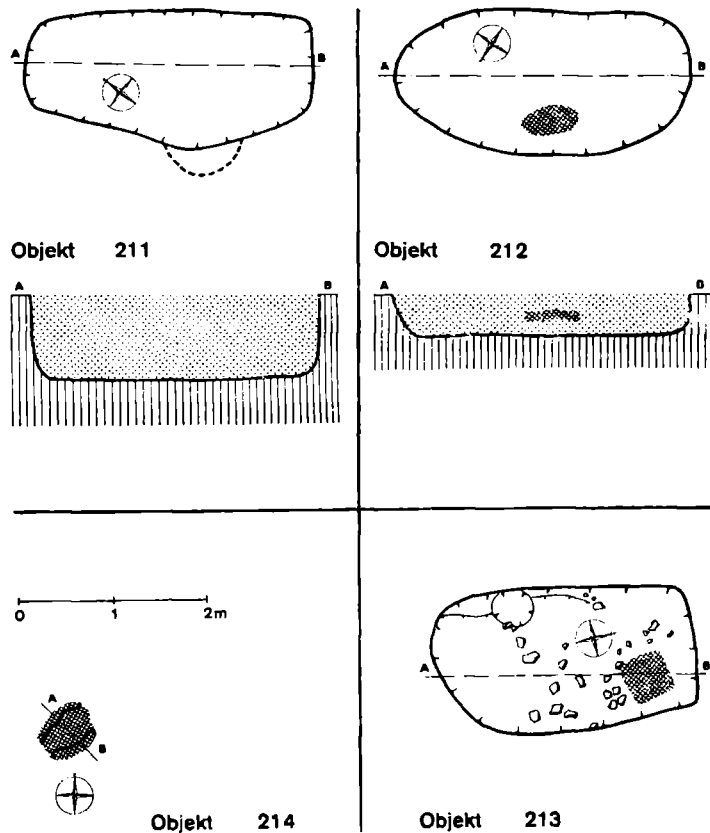
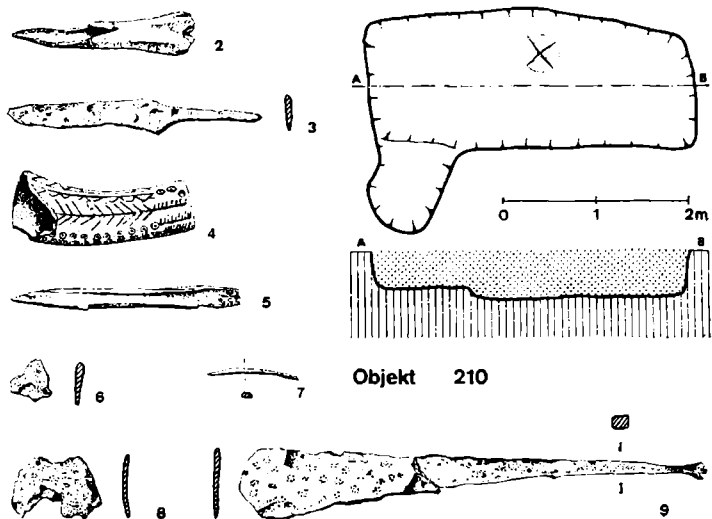
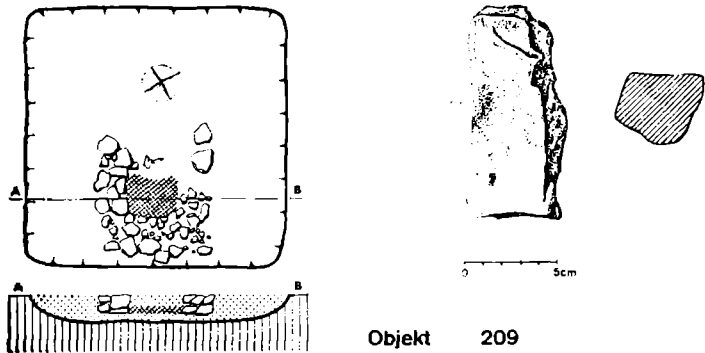

Tab. 81. Obj. 209: 1—156865; obj. 210: 2—157128, 3—157124, 4—157130, 5—157120, 6—157126/2, 7—157127, 8—157126/1, 9—157125.

Tab. 82. Obj. 211; obj. 212; obj. 213; obj. 214.

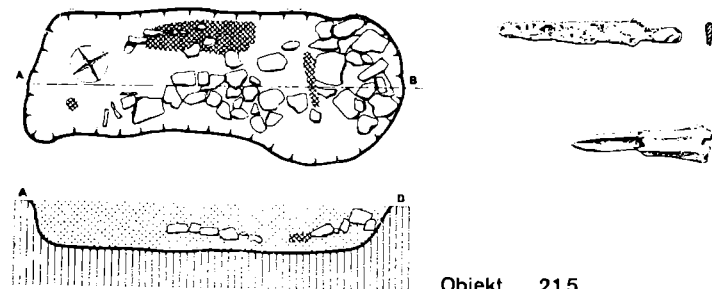

Objekt 215

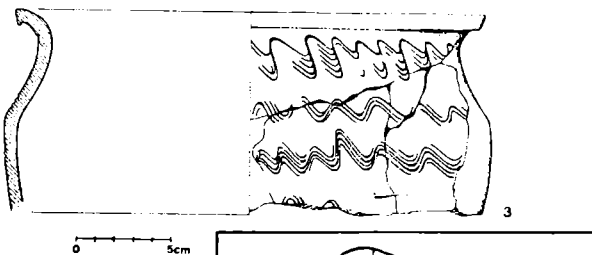

3

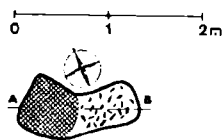

Objekt 217

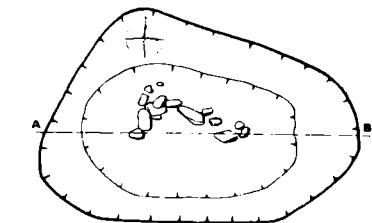

Objekt 216

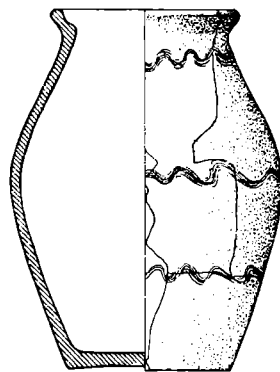
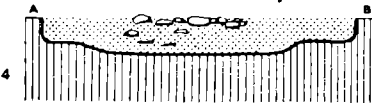

0 5cm

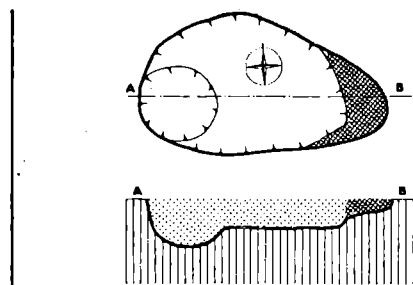

Objekt 218

219 Objekt

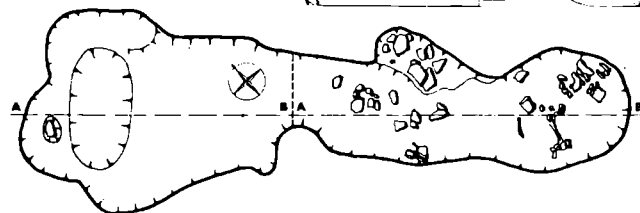
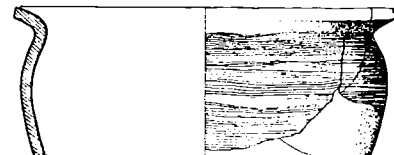

Objekt 228

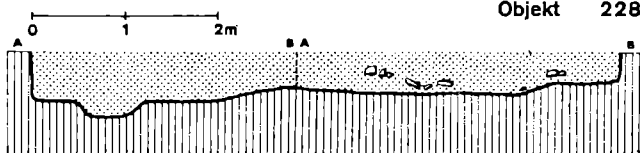

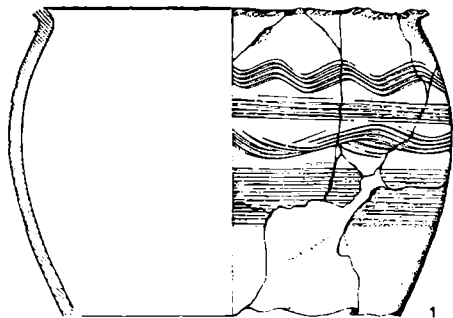

0 5cm

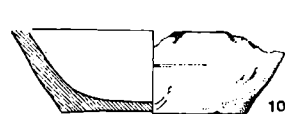
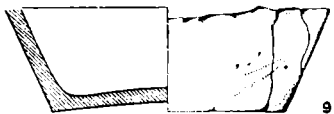
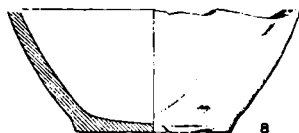
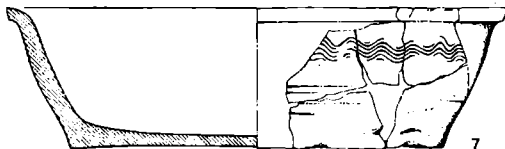

Objekt 219

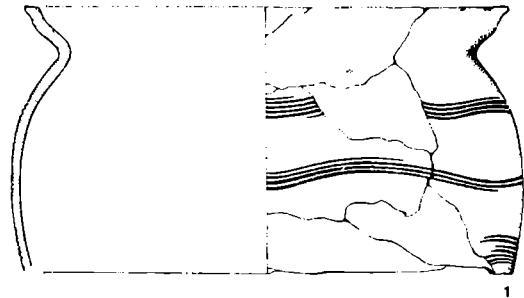

1

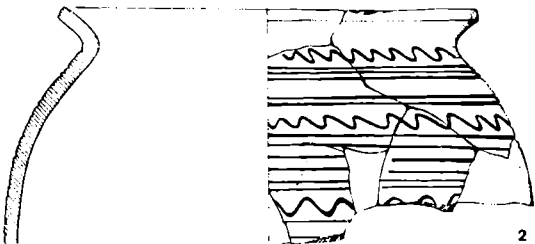

2

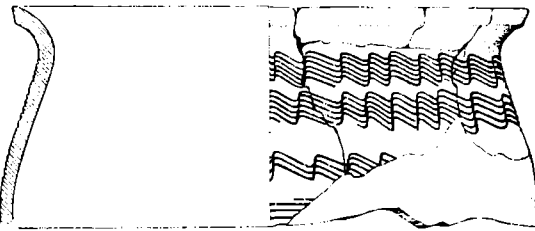

3

Objekt 219

0 5cm



4

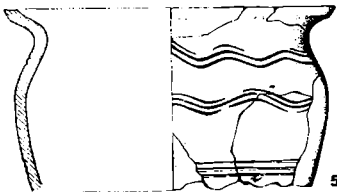

5

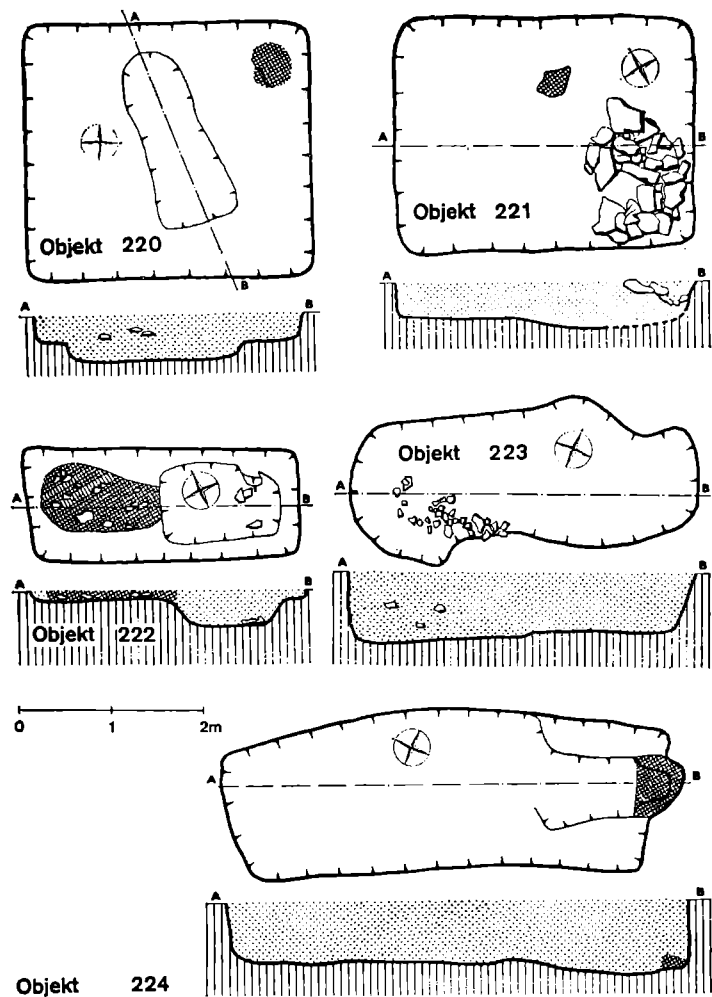

Tab. 87. Obj. 220; obj. 221; obj. 222; obj. 223; obj. 224.

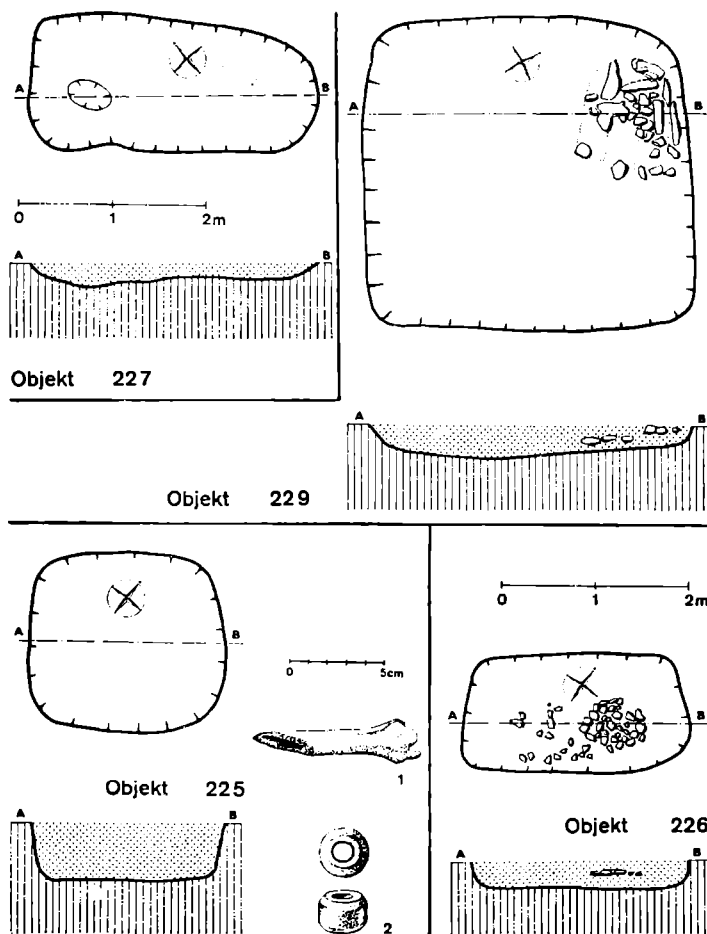

Tab. 88. Obj. 225: 1—157495, 2—157494; obj. 226; obj. 227; obj. 229.

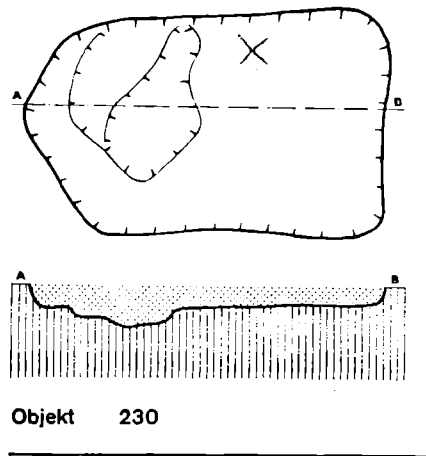

Objekt 230

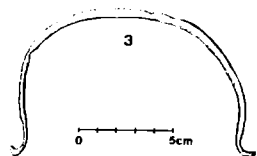
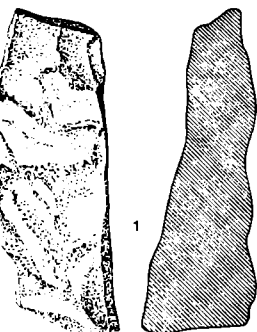
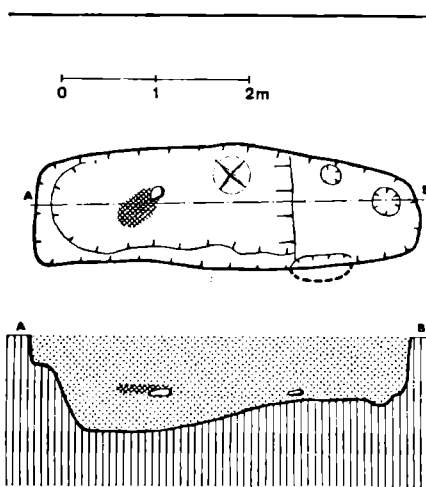

Objekt 231

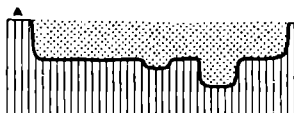
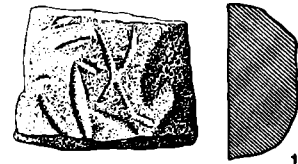
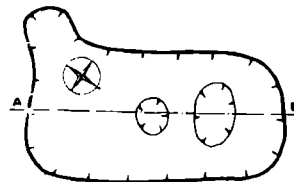

Objekt 232

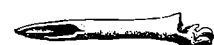
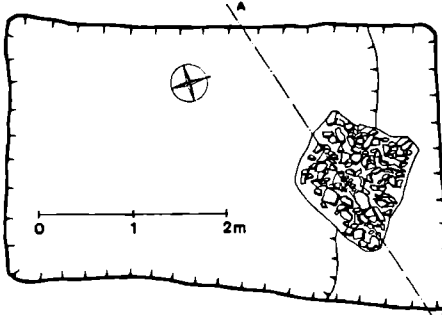

Objekt 233



Tab. 89. Obj. 230; obj. 231: 1-157676, 2-157674, 3-157670, 4-157671, 5-157673, 6,7-157672, 8-157675.

Tab. 90. Obj. 232: 1-157970, 2-157963, 3-157962, 4-157961, 5-157973, 6-157965/1, 7-157965/2, 8-157966, 9-157965/3, 10-157967, 11-157969, 12-157968, 13-157962; obj. 233.

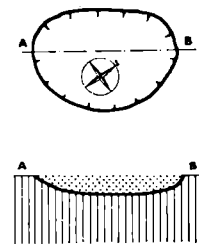
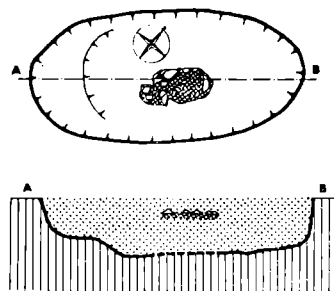
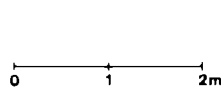
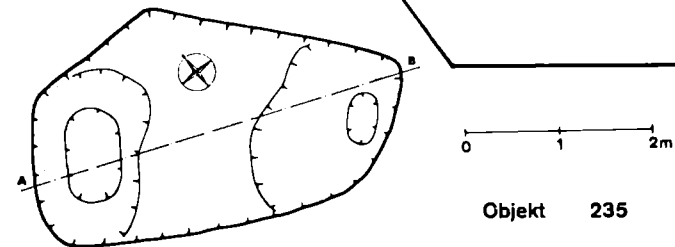
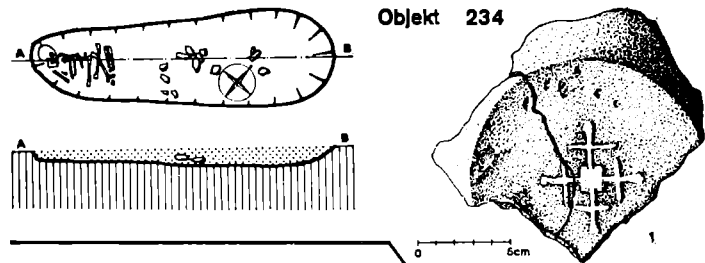

Objekt 237

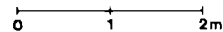

Objekt 240

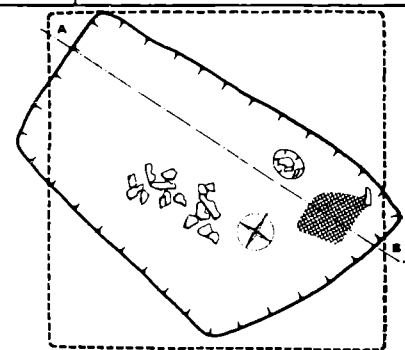
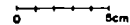

Objekt 239





Objekt 241

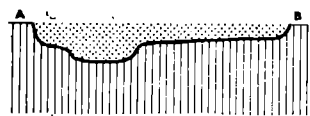
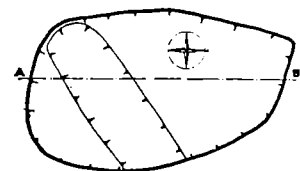

Objekt 243

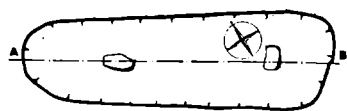
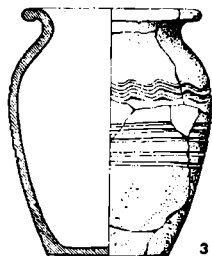

Objekt 242

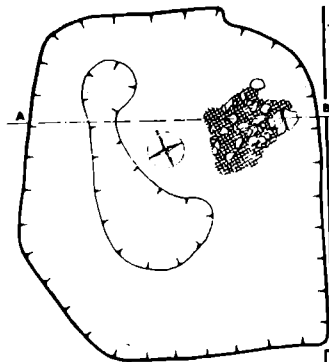
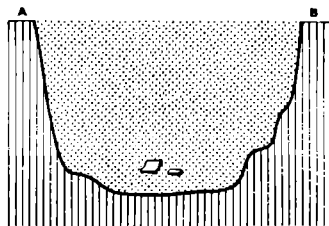
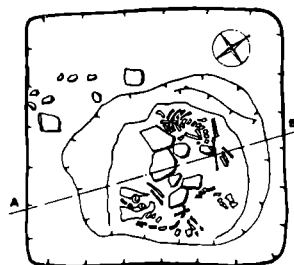

Objekt 244

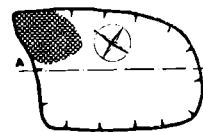
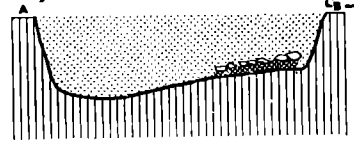

Objekt 245

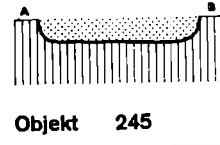

Objekt 246

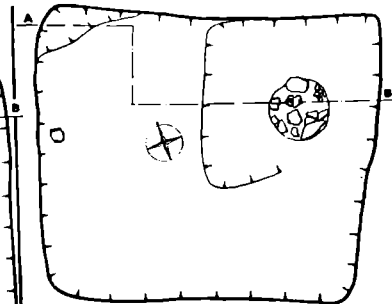

Objekt 247

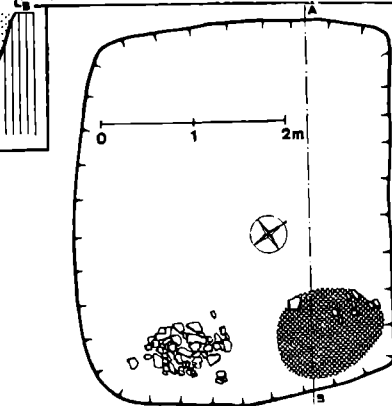
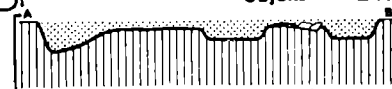

Tab. 95. Obj. 248; obj. 249; obj. 250; 1-158310; obj. 251.

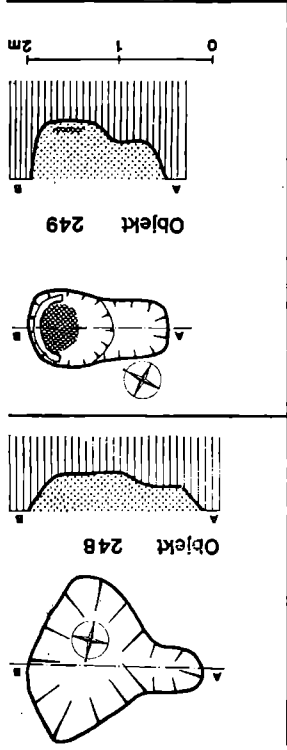
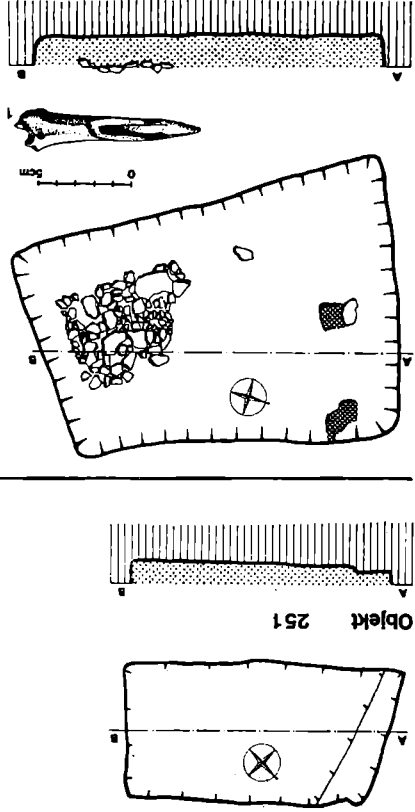

Objekt 250

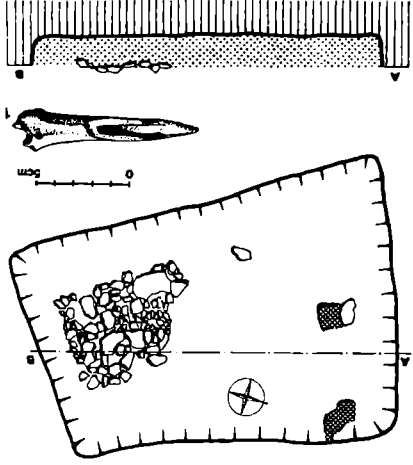

Tab. 96. Obj. 252: 1-158313, 2-158344, 3-158343; Obj. 253: 4-158357, 5-158356.

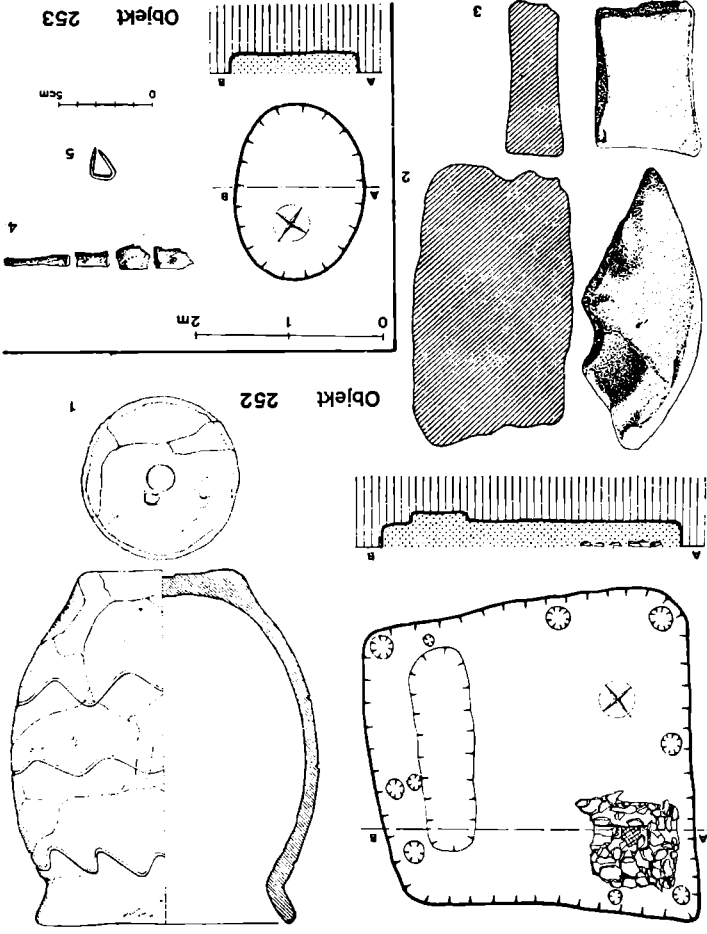

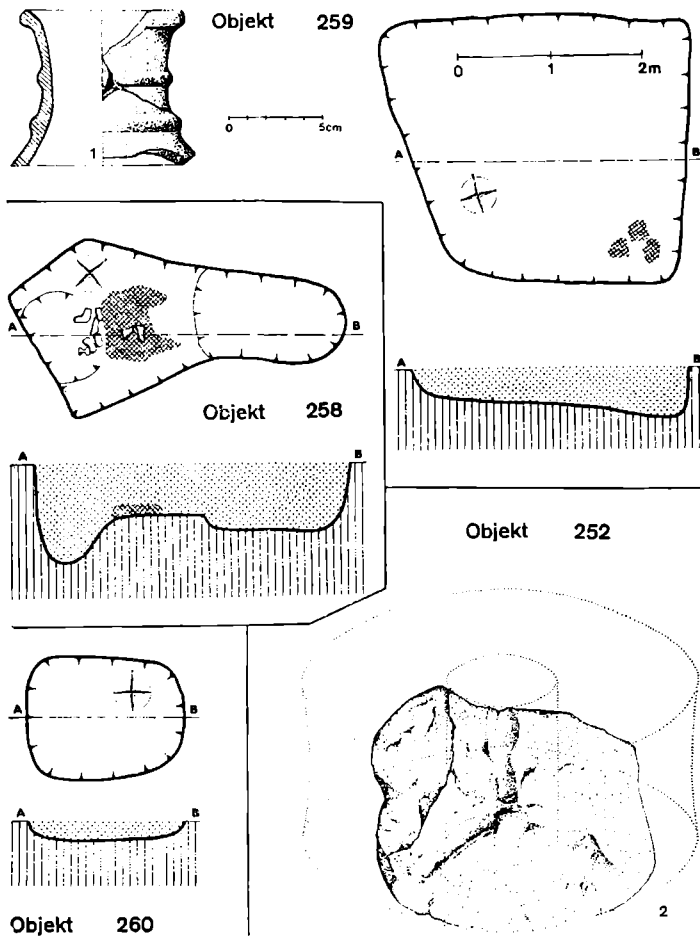
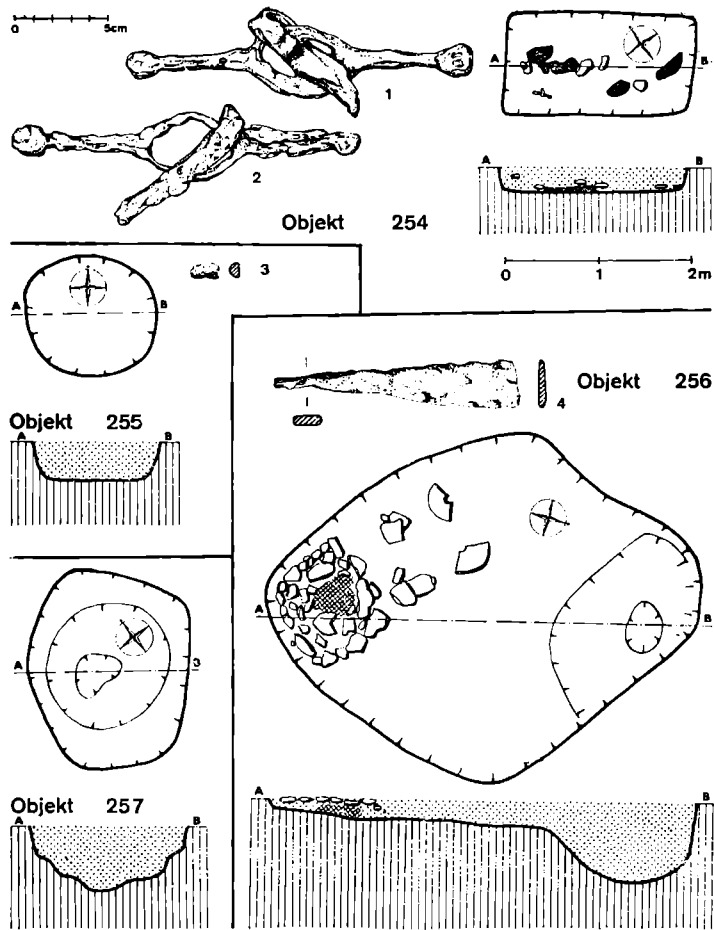

Tab. 97. Obj. 254: 1—158361, 2—158362; obj. 255: 3—reinv.; obj. 256: 4—158424; obj. 257.

Tab. 98. Obj. 258: 1—158426; obj. 259; obj. 260; obj. 252: 2—158344.

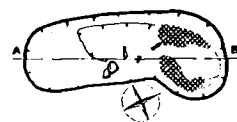
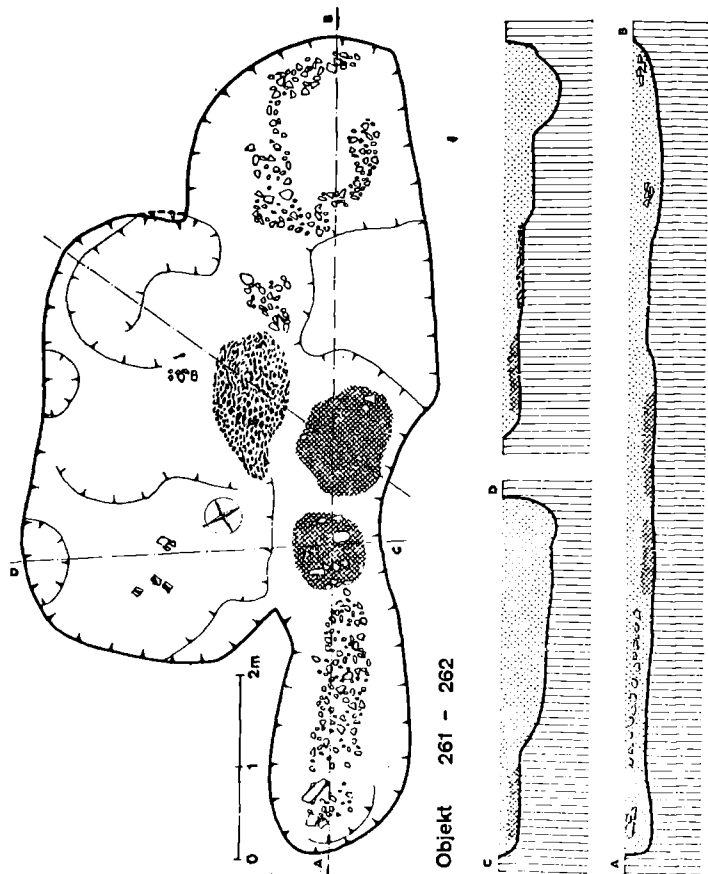

Objekt 263

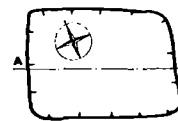

Objekt 266

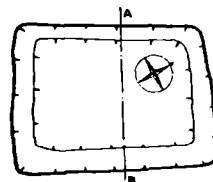

Objekt 268

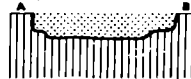

Objekt 265



Objekt 270

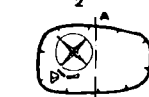
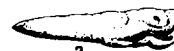

Tab. 99. Obj. 261-262.

Objekt 264

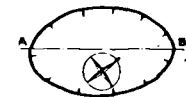
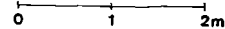
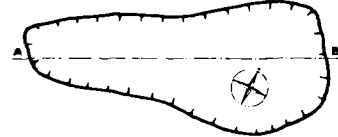
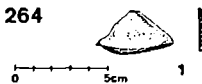

Objekt 267

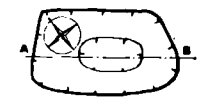
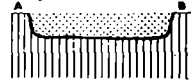

Objekt 269



Tab. 100. Obj. 263; obj. 264: 1-158483; obj. 265; obj. 266; obj. 267; obj. 268;

obj. 269; obj. 270: 2-158650.

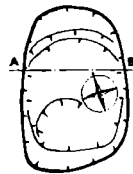

Objekt 271

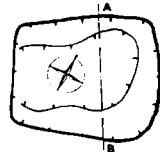
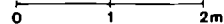
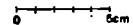
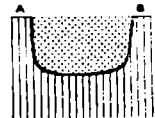

Objekt 272

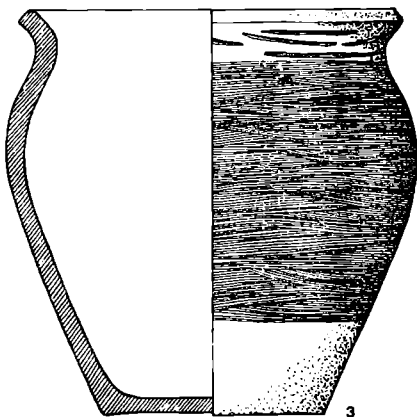
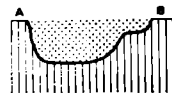

Objekt 273

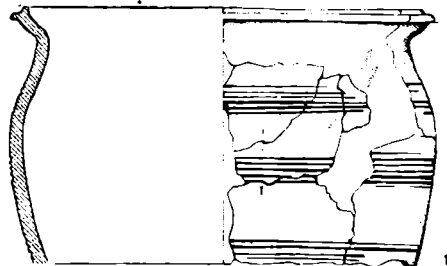

Objekt 273

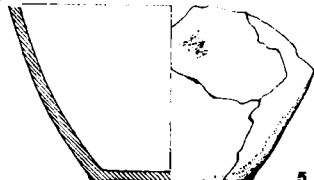
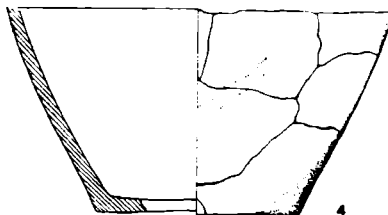
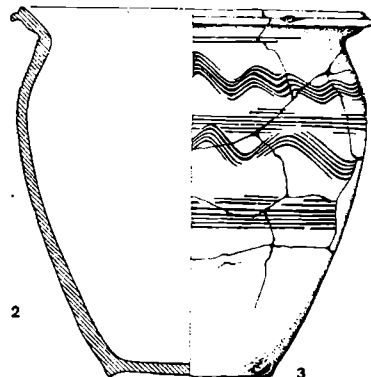
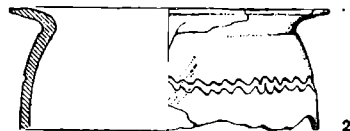
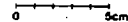

Tab. 101. Obj. 271: 1,2—158660/1,2 obj. 272: 3—158661; obj. 273: 4—158667, 5—158666, 6—158668.

Tab. 102. Obj. 273: 1—159280, 2—159278, 3—159277, 4—159350, 5—159279.

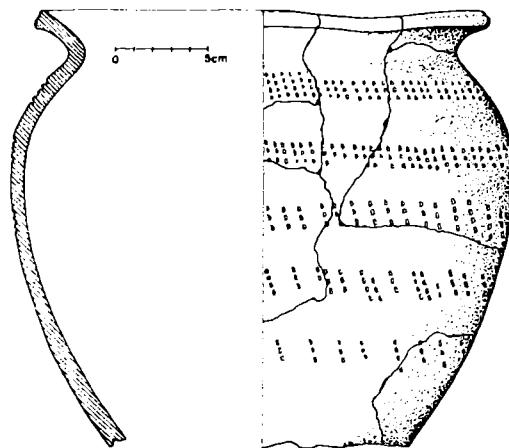
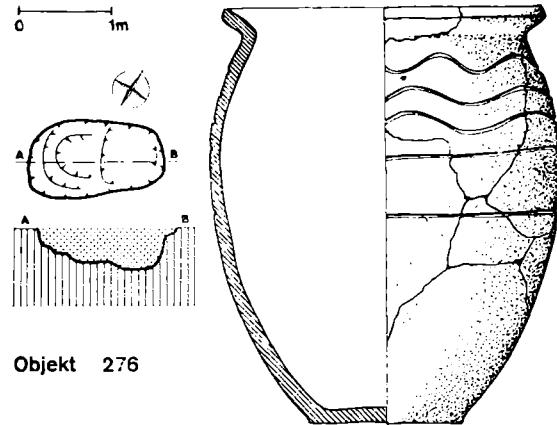
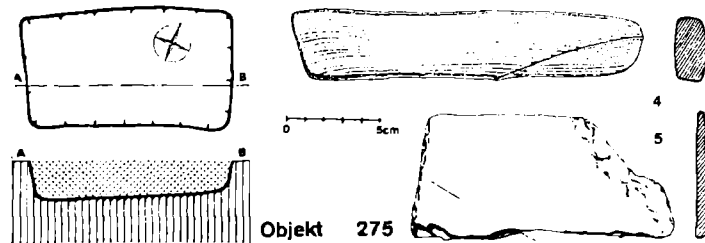
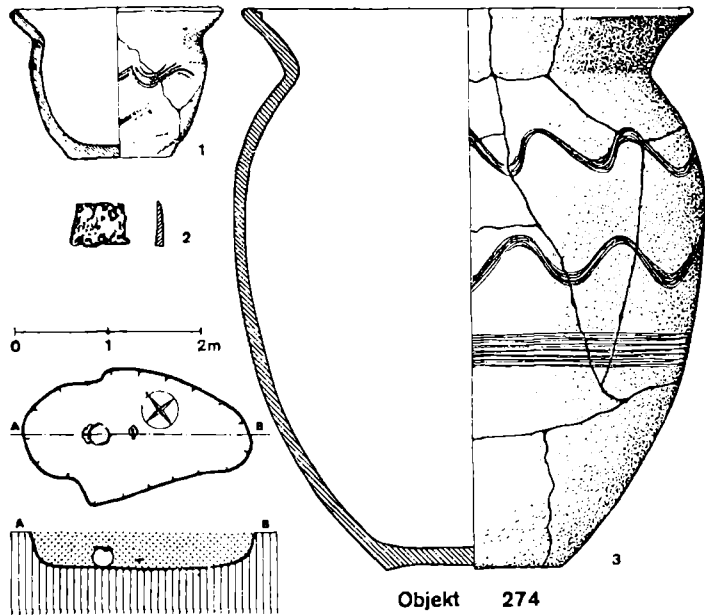

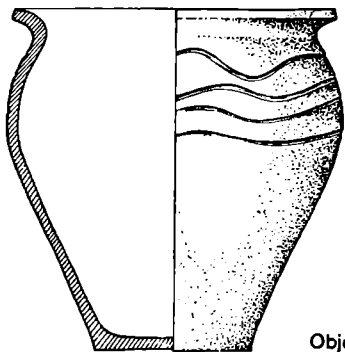

Objekt 276

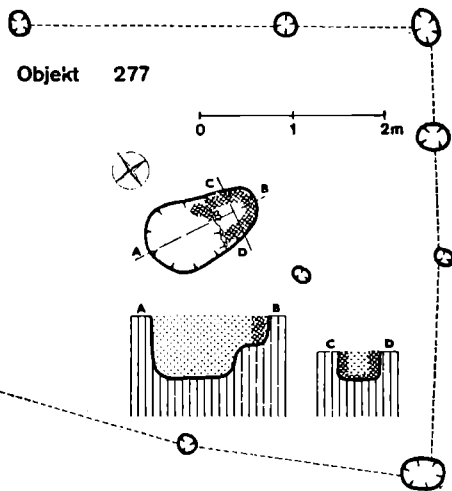

Objekt 277

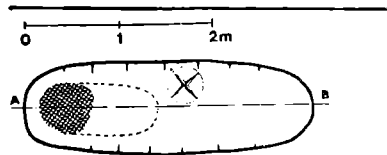
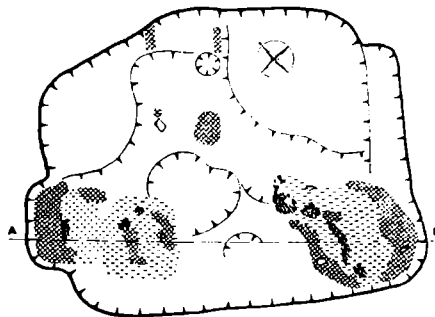

Objekt 279



0 5cm

Objekt 278

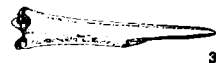

3

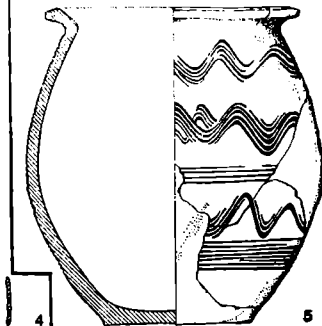

5

Tab. 105. Obj. 276: 1-158725; obj. 277.

Tab. 106. Obj. 278: 1-158822, 2-158823, 3-158324, 5-159275; obj. 279: 4-158829.

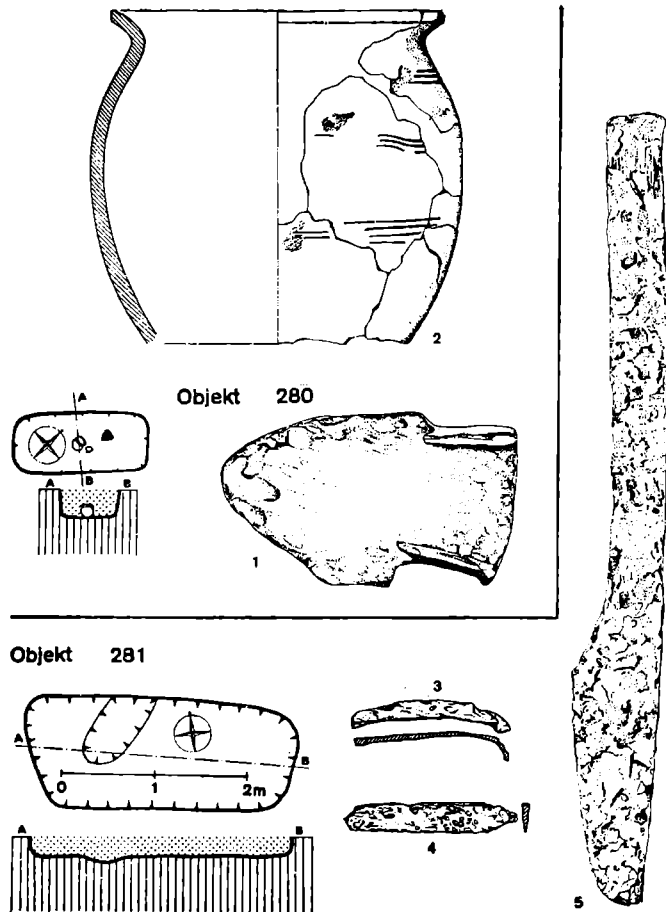

Tab. 107. Obj. 280: 1—158838; obj. 281: 2—158843, 3—158842/2, 4—158842/1.

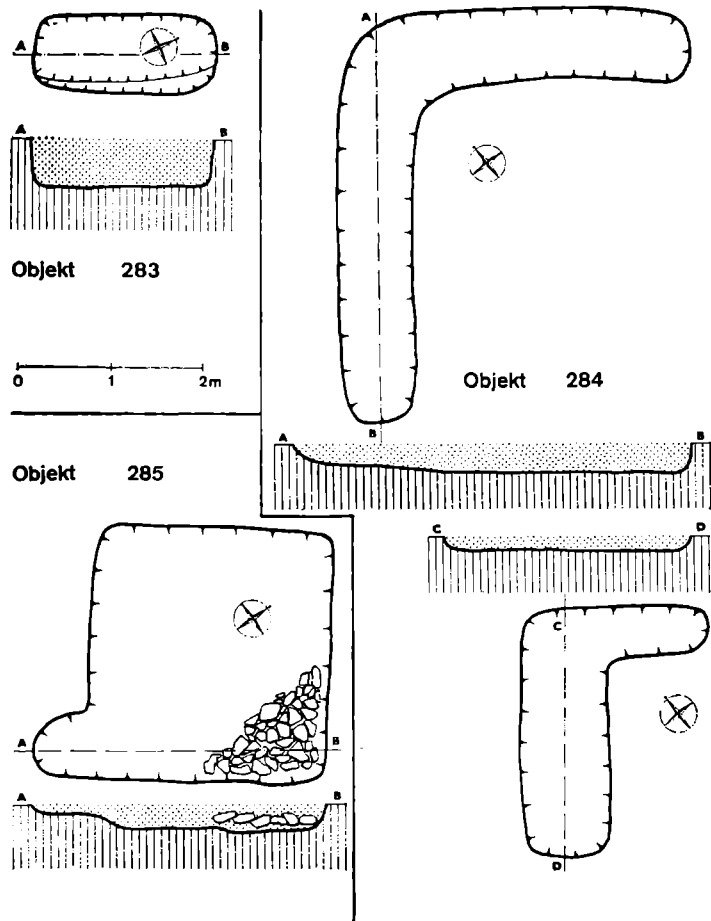

Tab. 108. Obj. 283; obj. 284; obj. 285.

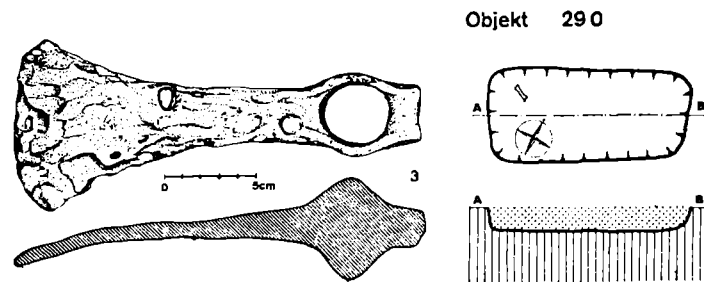
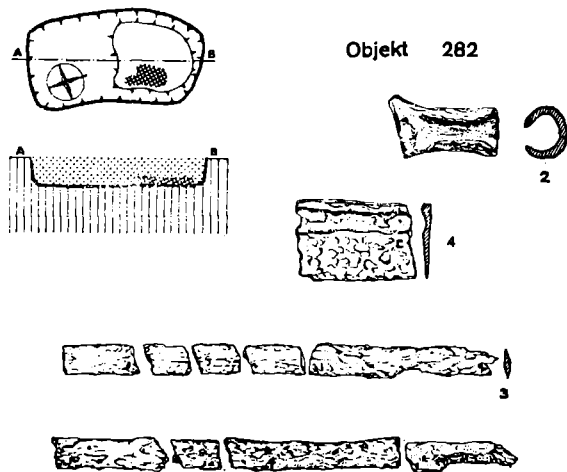
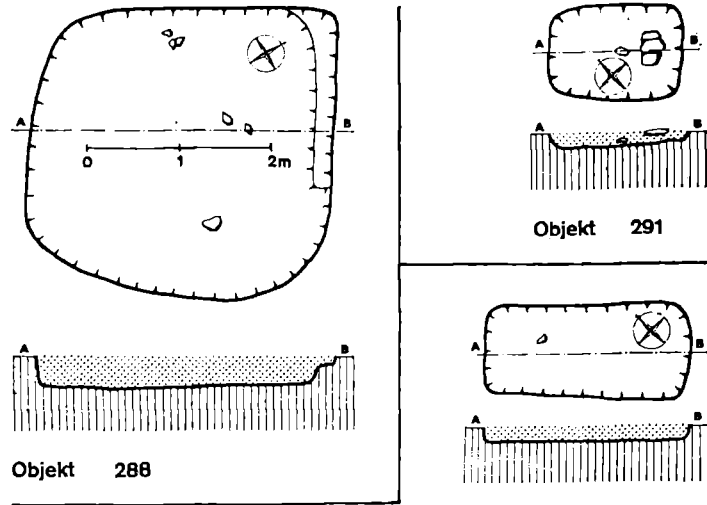
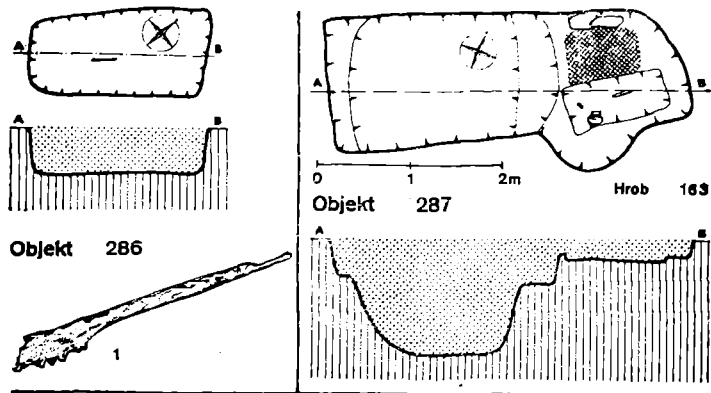

Tab. 109. Obj. 286: 1-161076; obj. 287; obj. 282: 2-158844, 3-158846, 4-158845.

Tab. 110. Obj. 288; obj. 289: 1-161097, 2-161098; obj. 290: 3-161099; obj. 291.

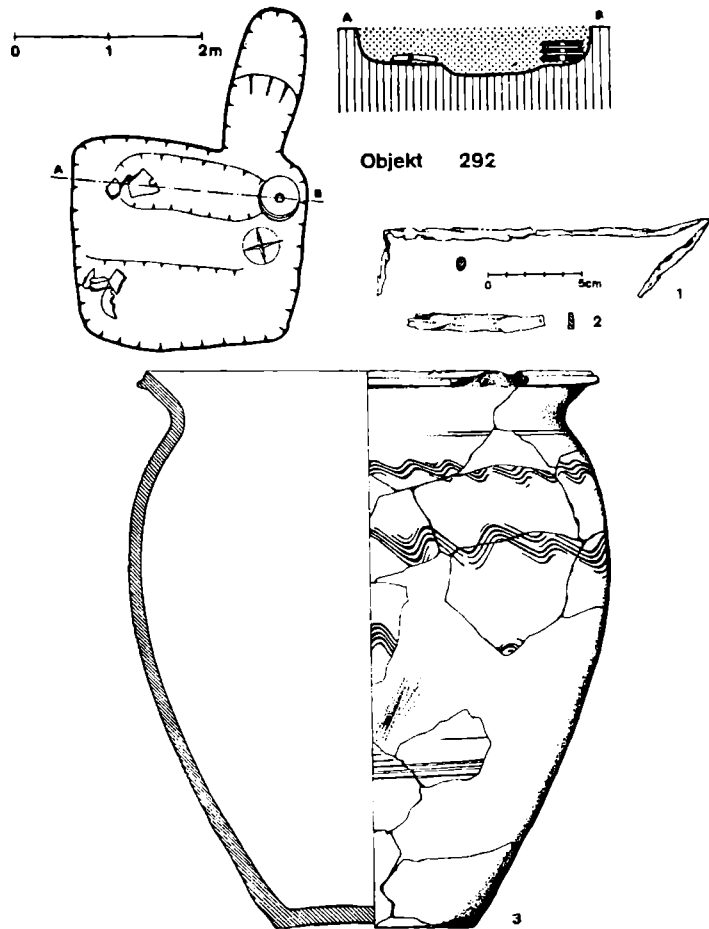

Таб. III. Obj. 292: 1—161188, 2—161187, 3—161100.

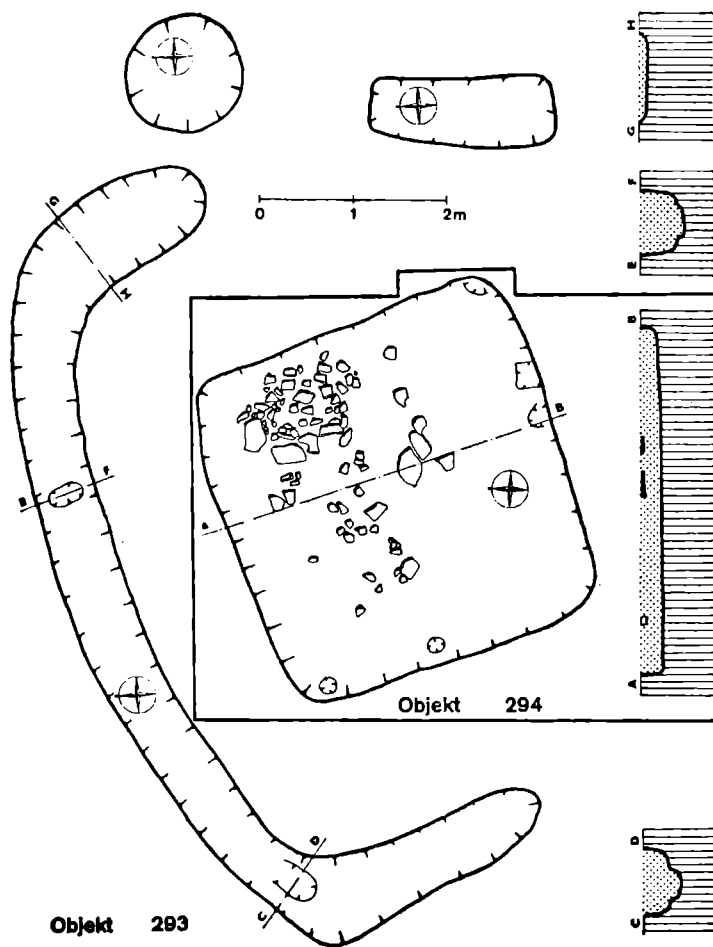

Таб. III. Obj. 293.

Objekt 293  1

Objekt 294



0 5cm

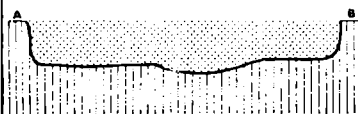
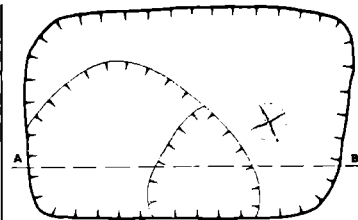

Objekt 295  5

0 1 2m

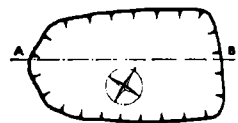

Objekt 296

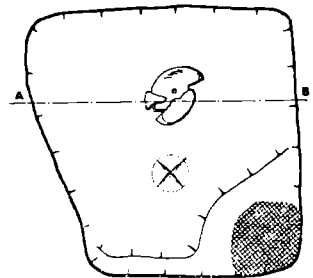

Objekt 297

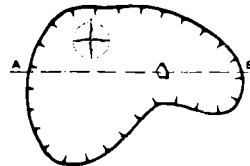

Objekt 298

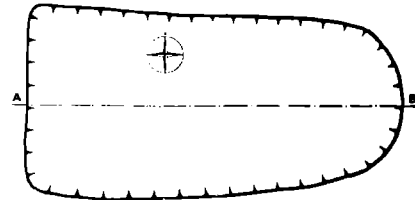

Objekt 299

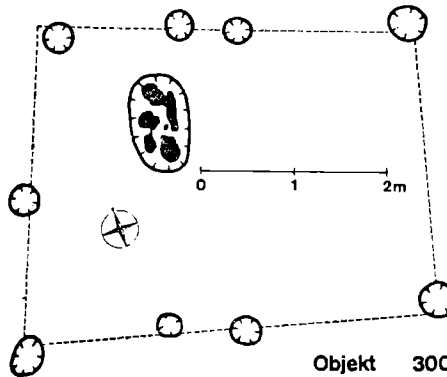

Objekt 300

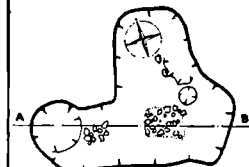

Objekt 301

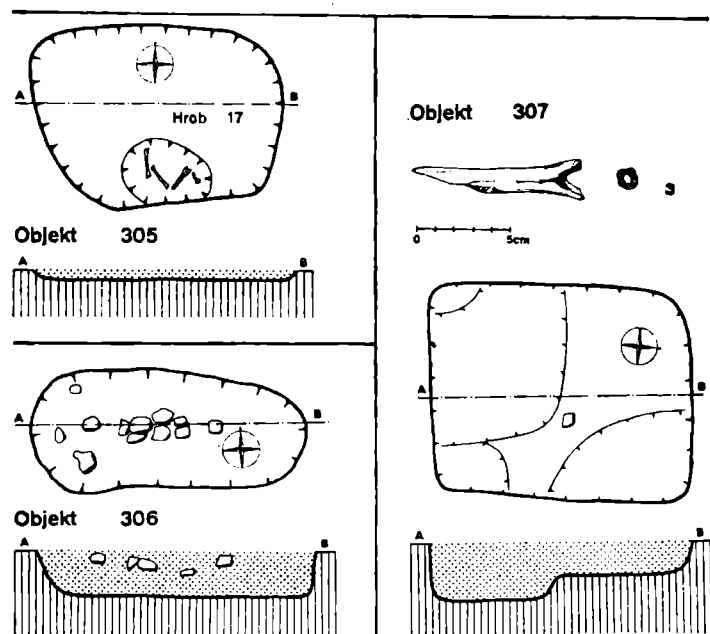
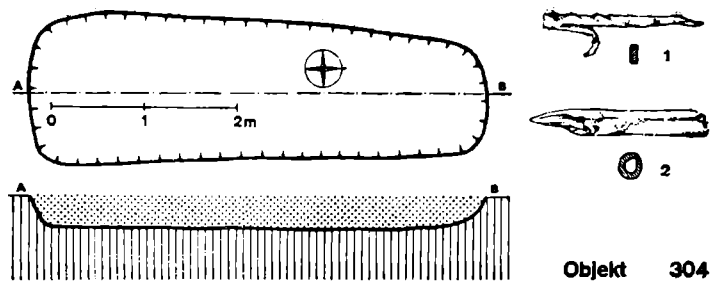
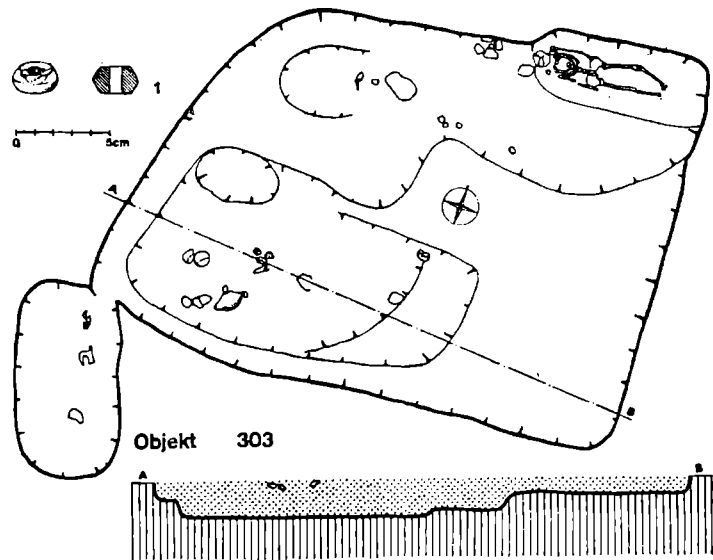
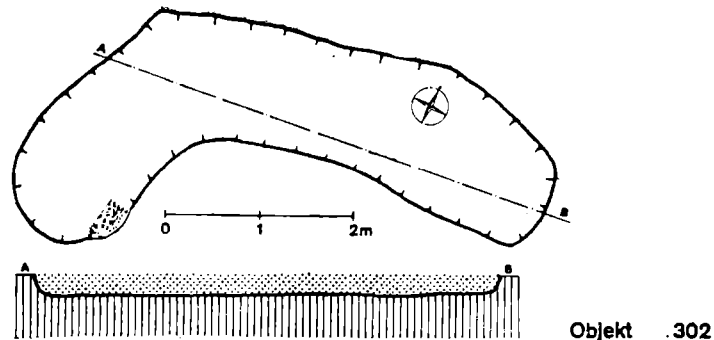

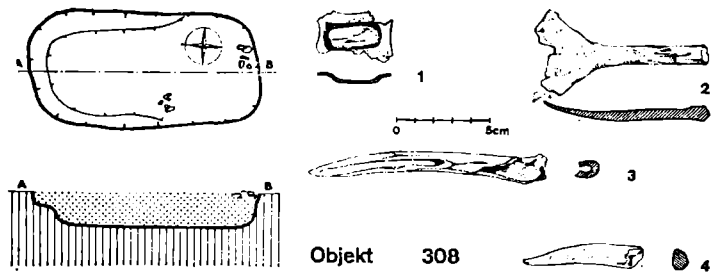

Objekt 308

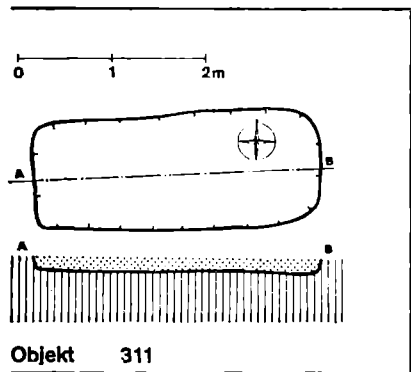

Objekt 311

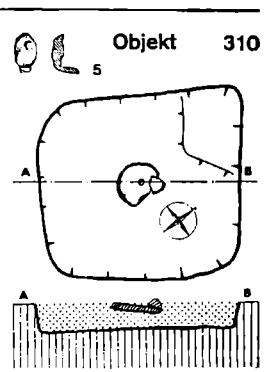

Objekt 310

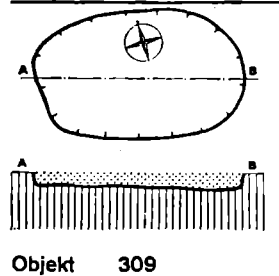

Objekt 309

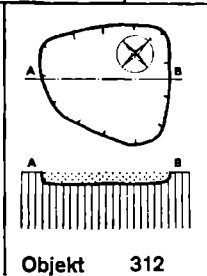

Objekt 312

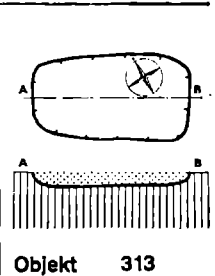

Objekt 313

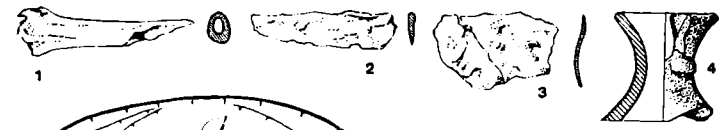

Objekt 314

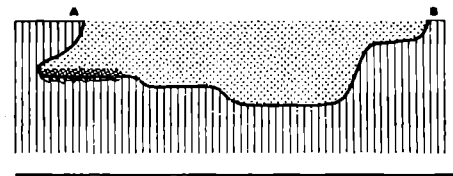

Objekt 316

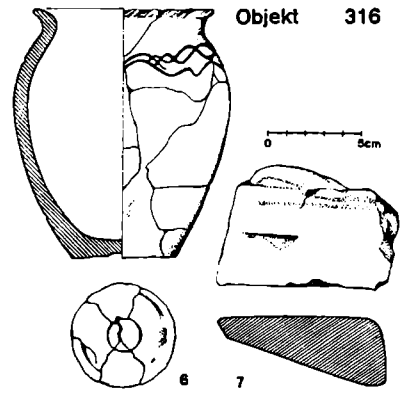

Objekt 315

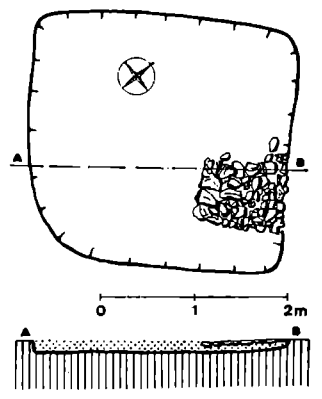

Tab. 118. Obj. 314: 1-162024, 2-162024, 3-162025, 4-161944; obj. 315: 6-162030; obj. 316: 5-162031, 7-162082.

Tab. 117. Obj. 308: 1-161917, 2-161916, 3-161918, 4-161919; obj. 309; obj. 310: 5-161927; obj. 311; obj. 312; obj. 313.

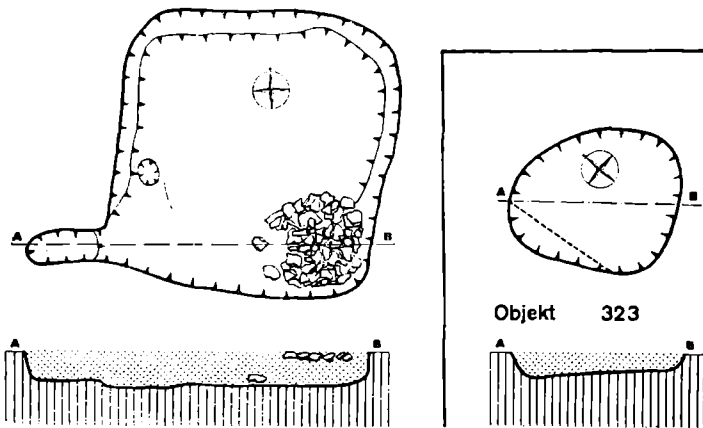
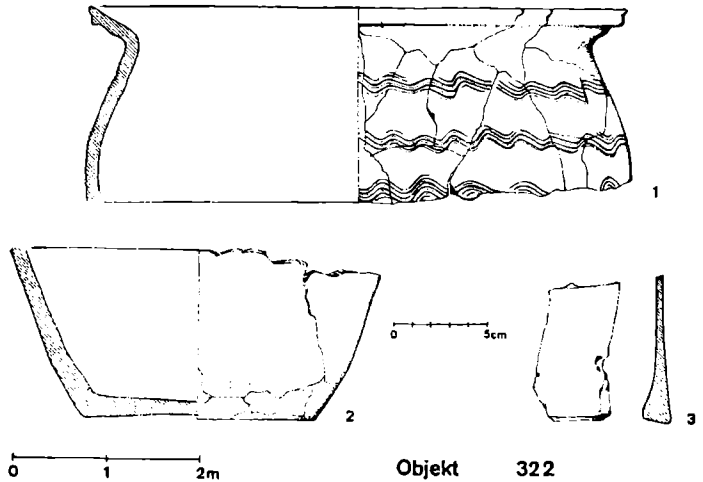
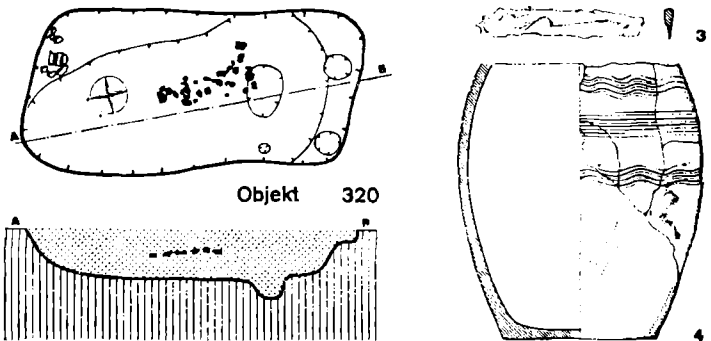
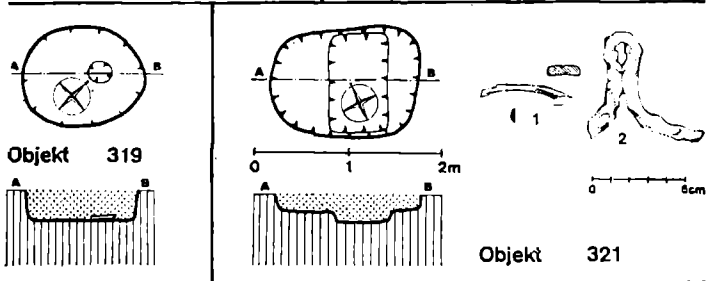
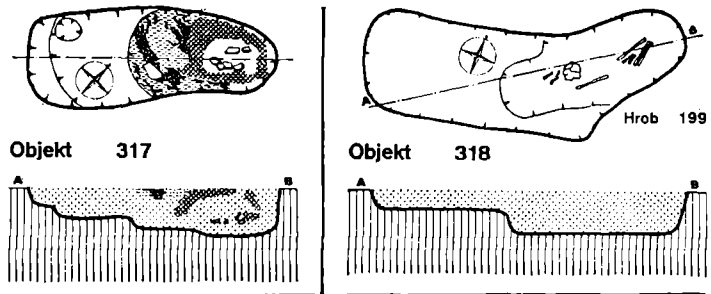

Tab. 119. Obj. 317; obj. 318; obj. 319; obj. 320: 3-162114, 4-162101; obj. 321: 1-162115/1, 2-162115/2

Tab. 120. Obj. 322: 1-162116, 2-162148-50, 3-162152; obj. 323.

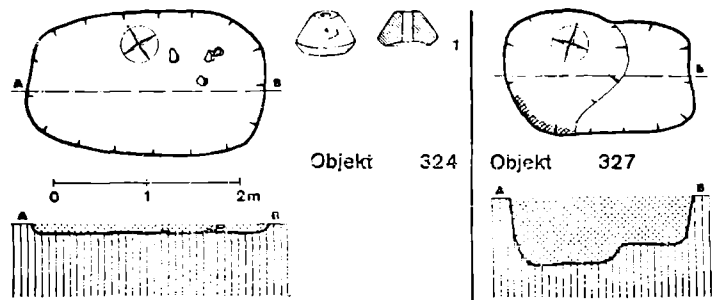

Objekt 324

Objekt 327

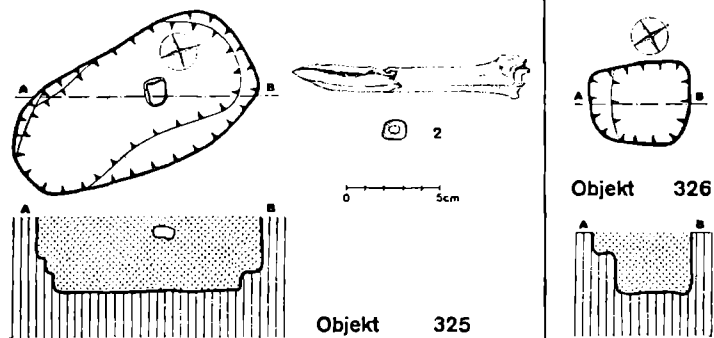
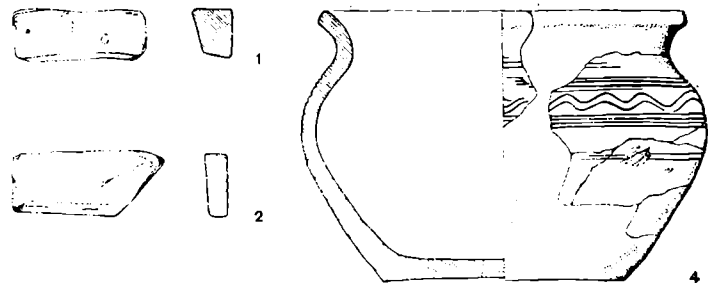

Objekt 325

Objekt 326

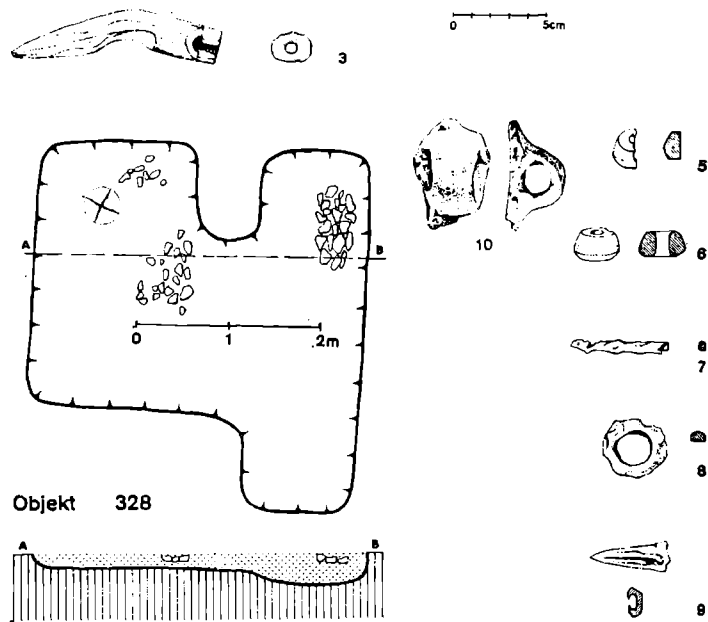

Objekt 328

Tab. 121. Obj. 324: 1-161172; obj. 325: 2-162185; obj. 326: čtv. N 22-2: 3-144392.

Tab. 122. Obj. 328: 1-162699, 2-162700, 3-162702, 4-162239, 5-162698, 6-162697, 7-162696, 8-162696, 9-162695, 9-162701, 10-162242.

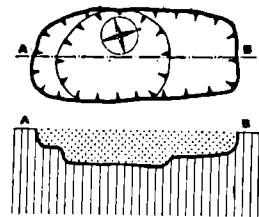

Objekt 329

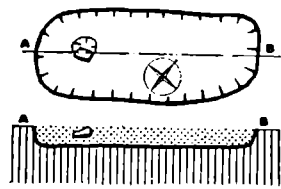

Objekt 332



Objekt 333

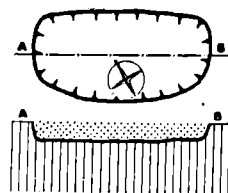
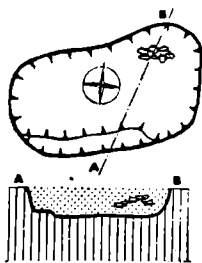

Objekt 330

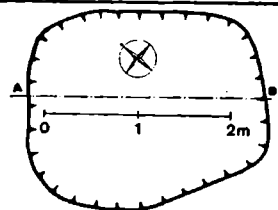

Objekt 331

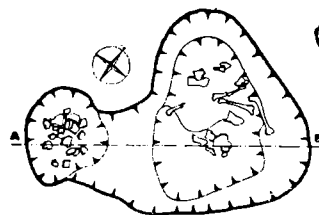

Objekt 334

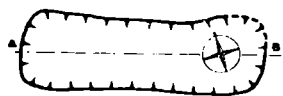

Objekt 336

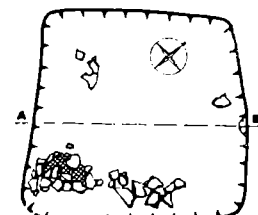
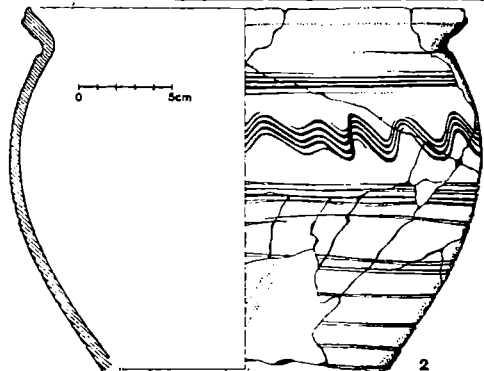
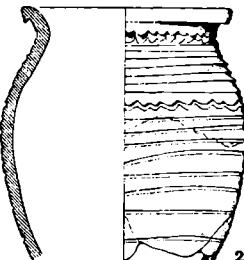
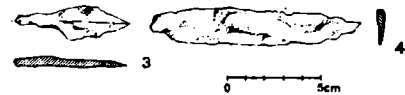

Objekt 335

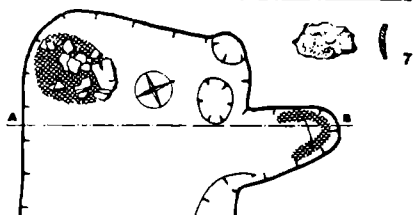

Objekt 337

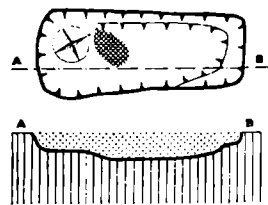

Objekt 338

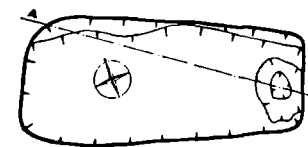

Objekt 340

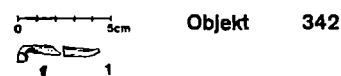

Objekt 342

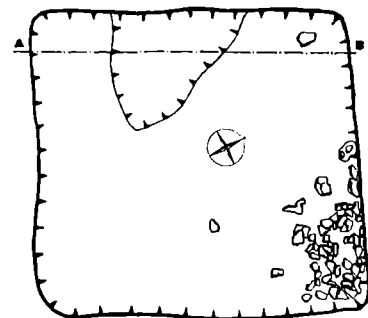
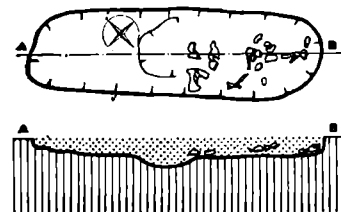

Objekt 339

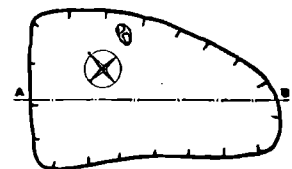
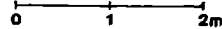
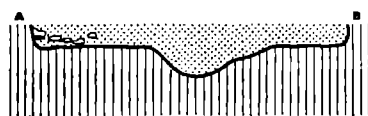

Objekt 341

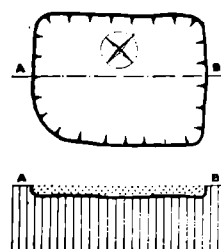

Objekt 343

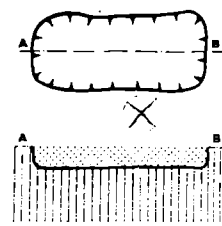
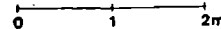

Objekt 344

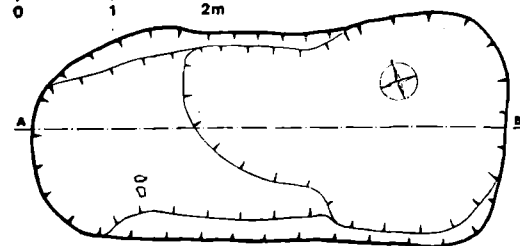

1

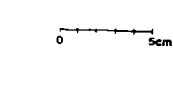

2

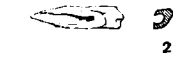
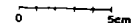

3



4



5



6

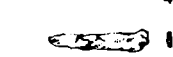

7



7



7



7



7



7



7



7



7



7

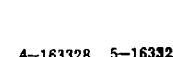

7

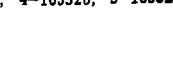

7

Tab. 125. Obj. 338; obj. 339; obj. 340; obj. 341; obj. 342: 1-163092.

Tab. 126. Obj. 343; obj. 344: 1-163322, 2-163327, 3-163325, 4-163328, 5-163323, 6-163324, 7-163326; obj. 345.

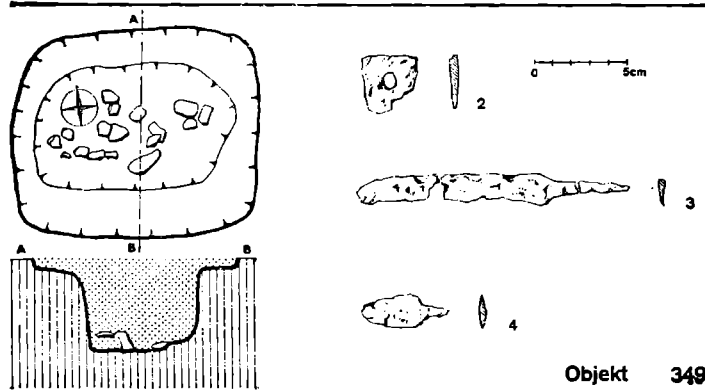
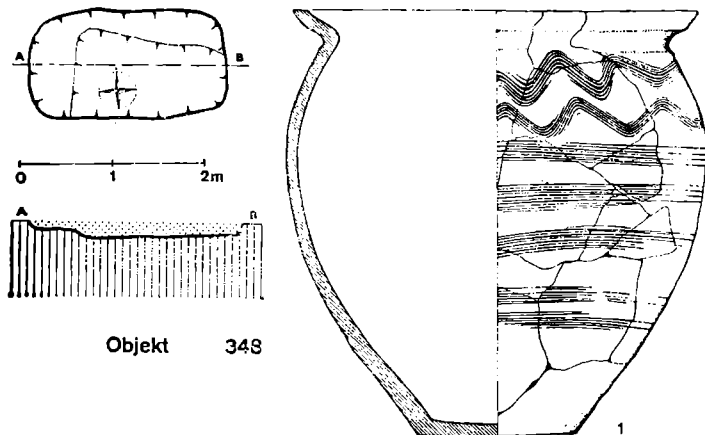
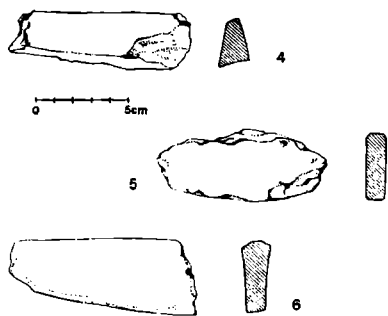
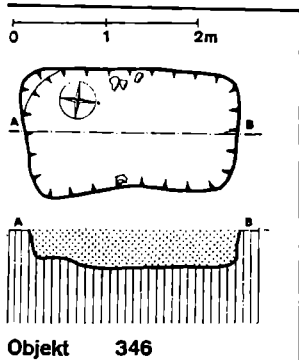
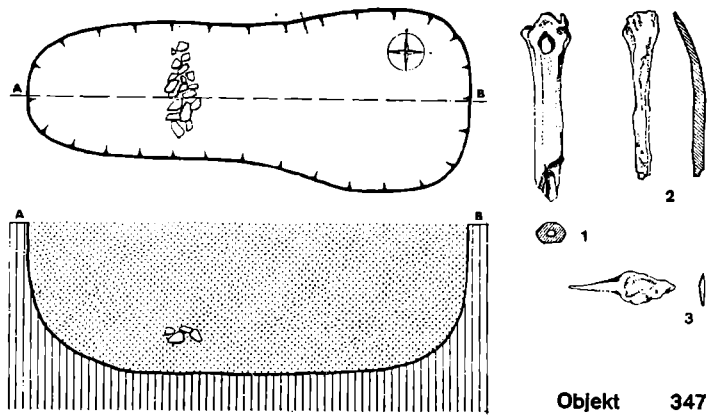

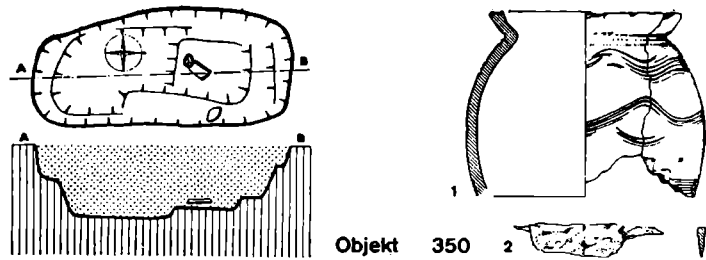

Objekt 350

0 1 2m

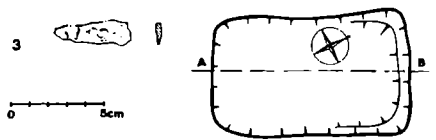
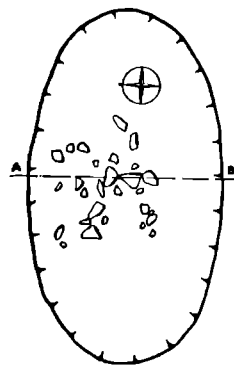

Objekt 351



Objekt 352

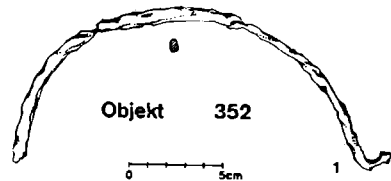

Objekt 352

0 5cm

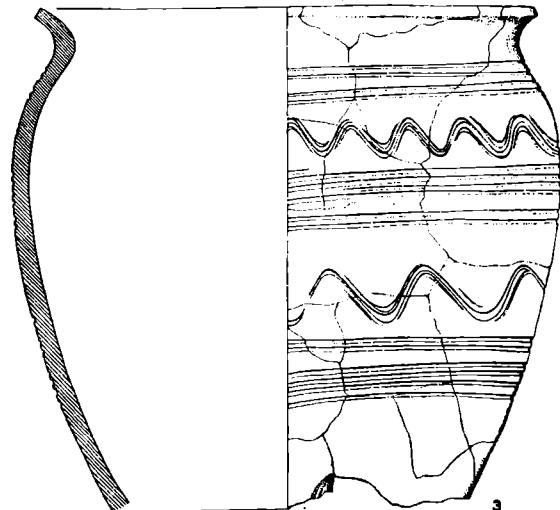
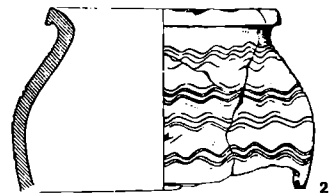

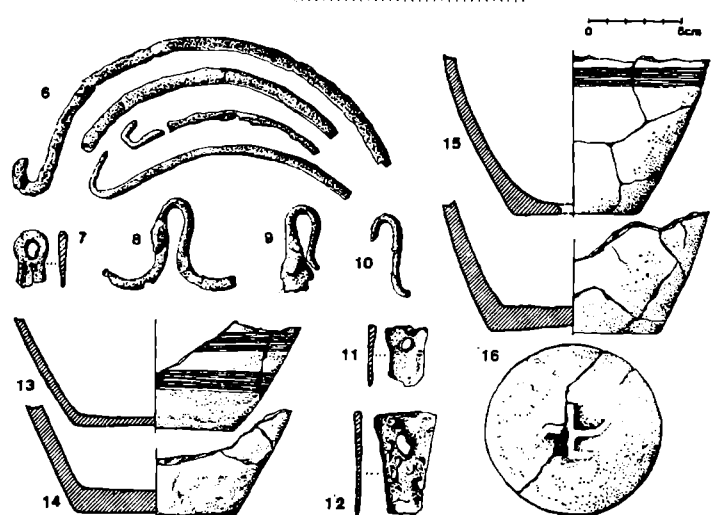
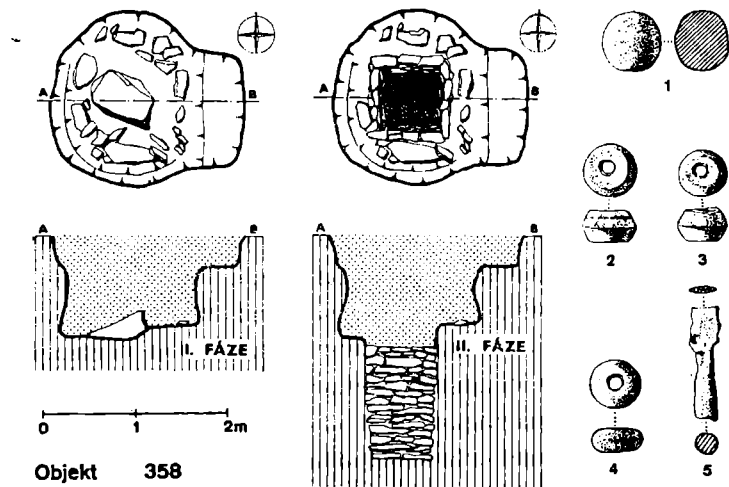
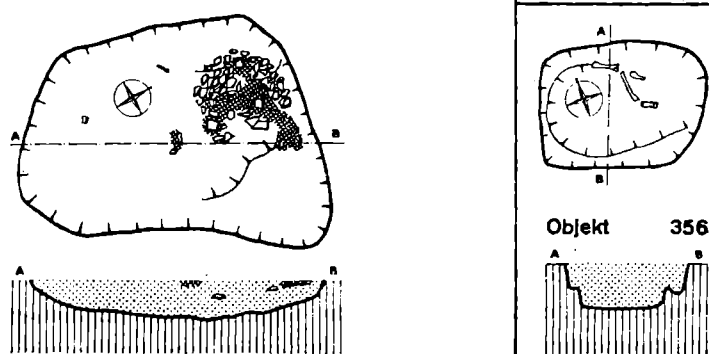
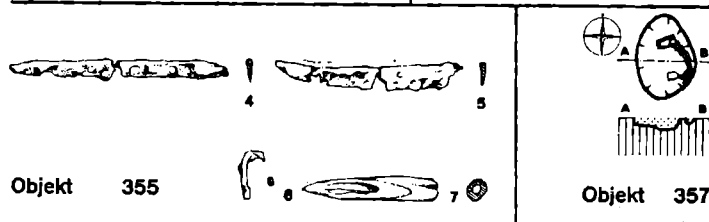
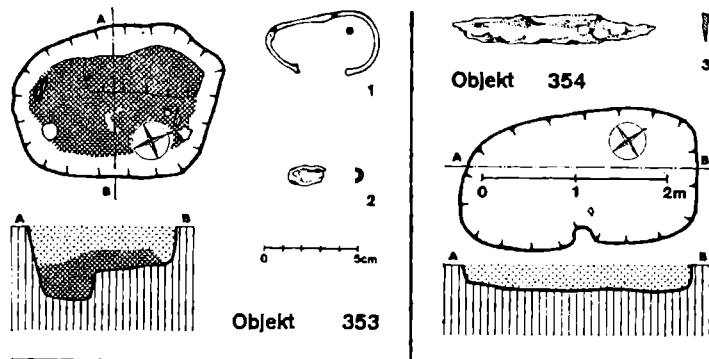

Tab. 131. Obj. 353: 1-164407, 2-164406; obj. 354: 3-164456; obj. 355: 4-164640, 5-164639, 6-164941, 7-164642; obj. 356; obj. 357.

Tab. 132. Obj. 358: 1-164725, 2-164721, 3-164722, 4-164723, 5-164704, 6-164711-17, 7-164707, 8-164705, 9-164706, 10-164718, 11-164709, 12-164708, 13-164695, 14-164696, 15-164697, 16-164694.

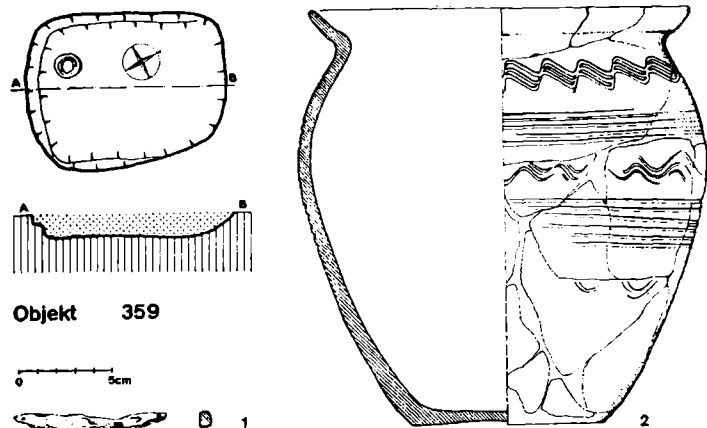

Objekt 359

0 5cm

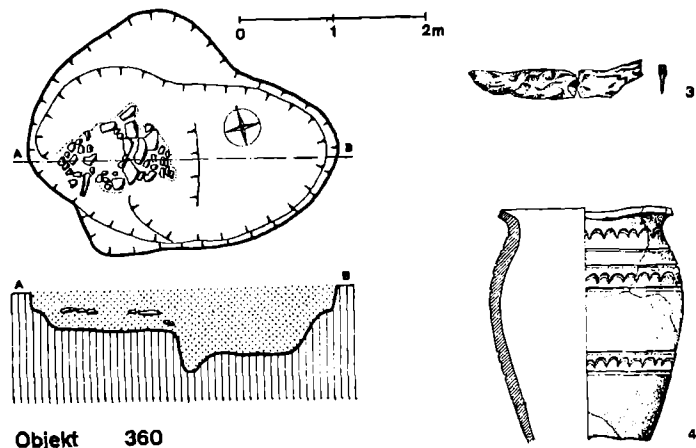

Objekt 360

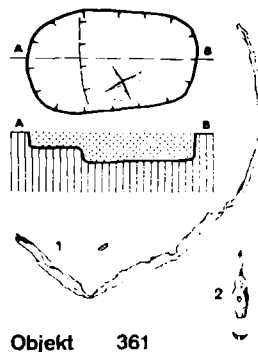

Objekt 361

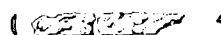

Objekt 363

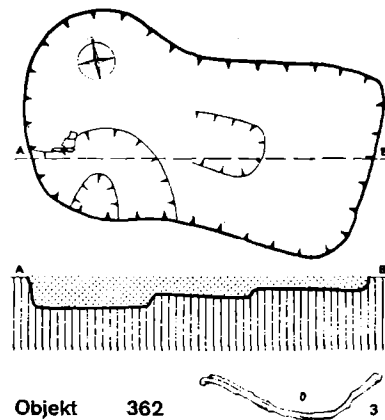

Objekt 362



Objekt 366

0 5cm

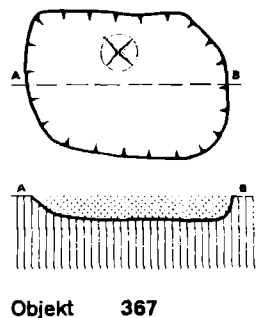

Objekt 367

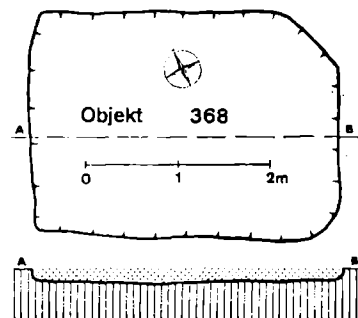

Objekt 368

0 1 2m

Tab. 132. Obj. 359: 1-164747, 2-164729; obj. 360: 3-164857, 4-164748.

Tab. 134. Obj. 361: 1-164912, 2-164913; obj. 362: 3-164918; obj. 363: 4-165016, 5-165015; obj. 366: 6-168286; obj. 367; obj. 368.

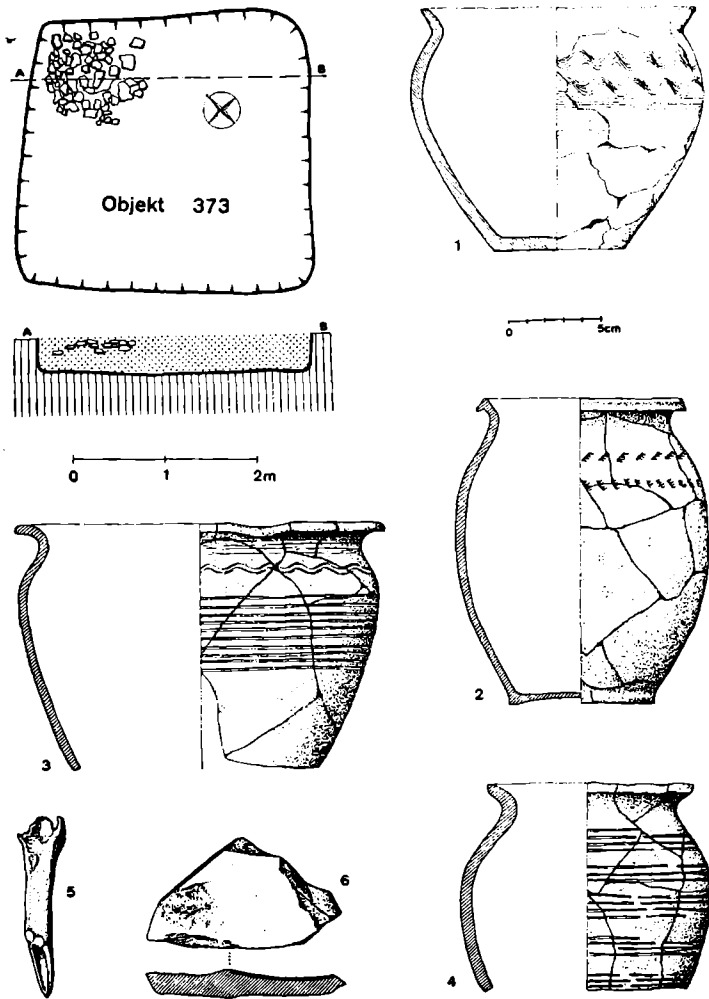
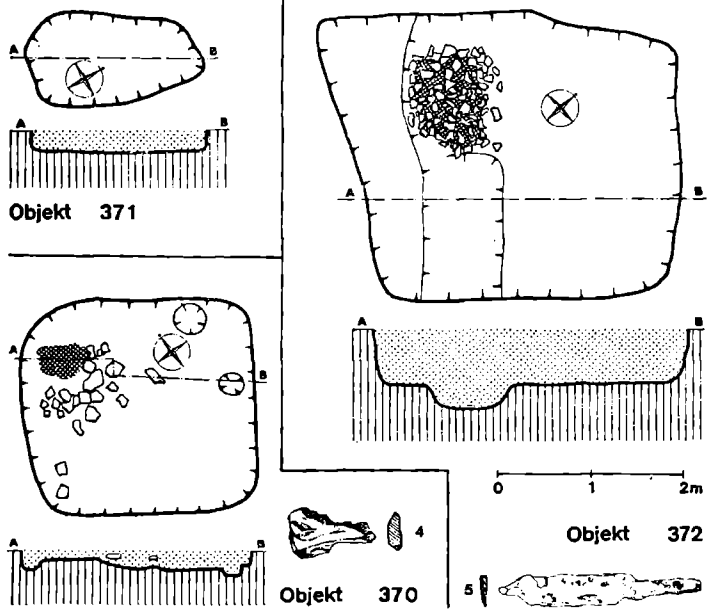
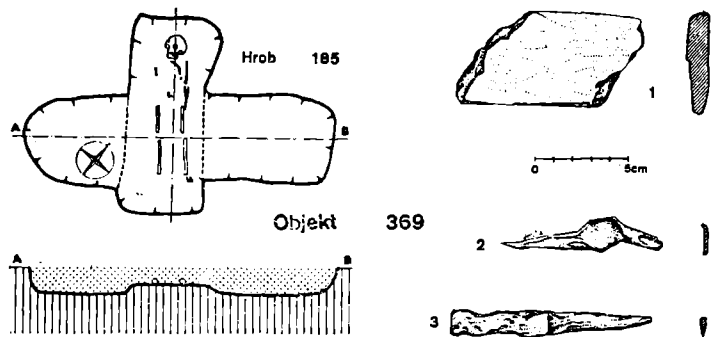

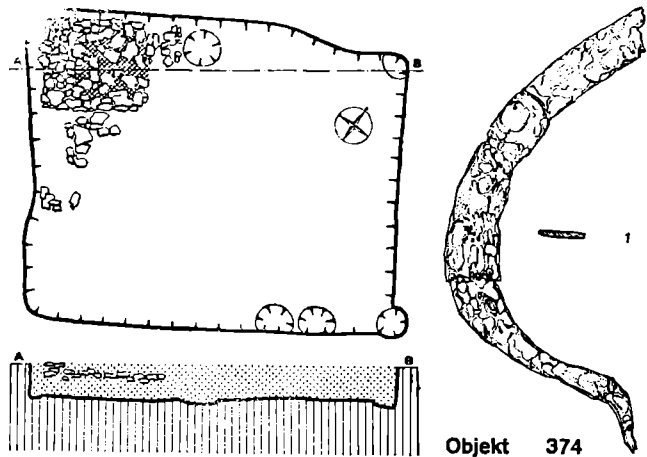

Objekt 374

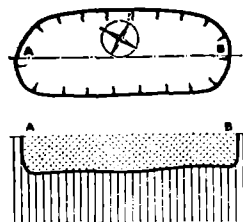
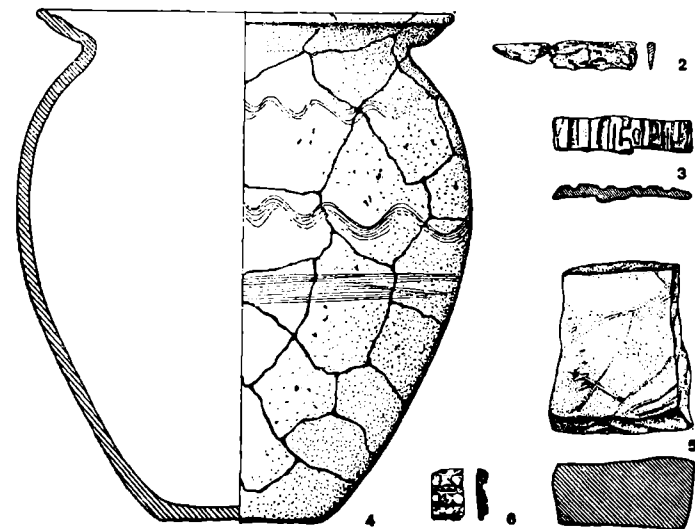

Objekt 375

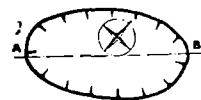

Objekt 376

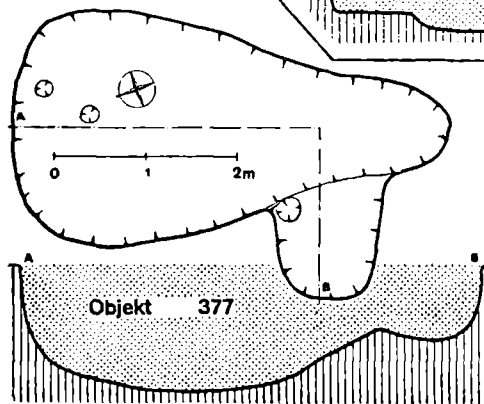

Objekt 377

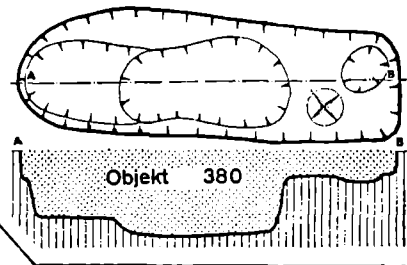
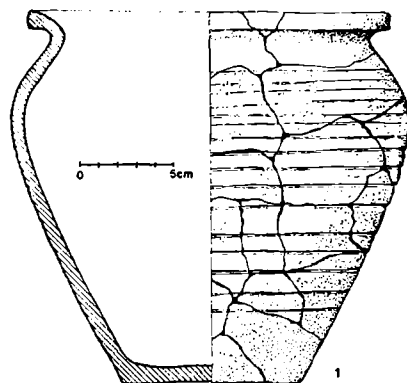

Objekt 380

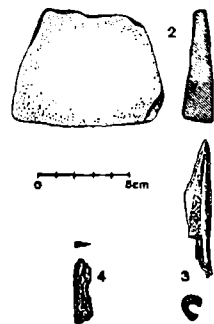

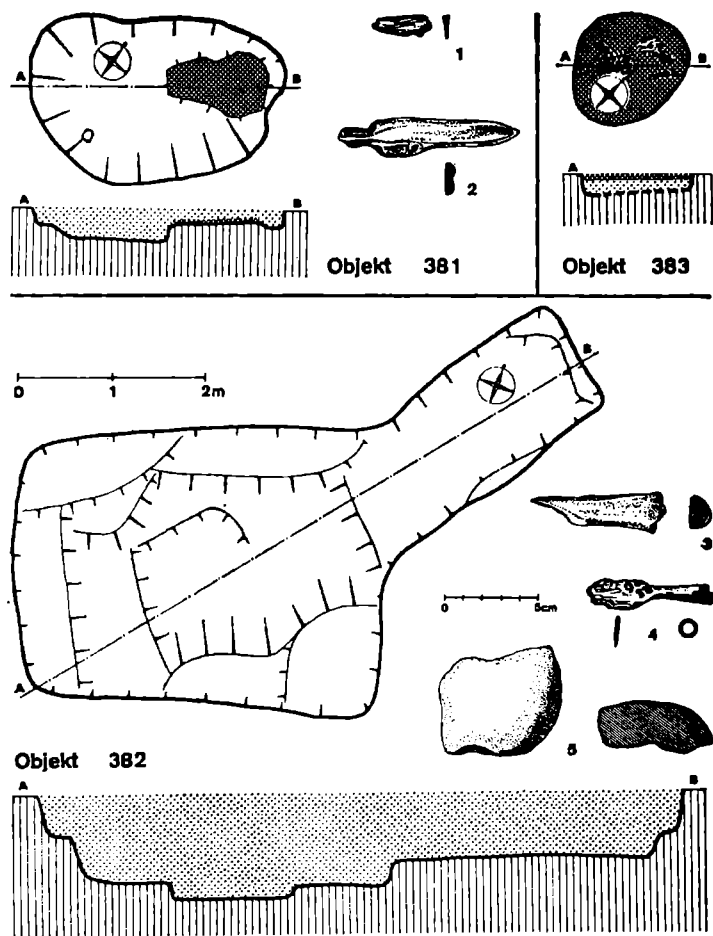
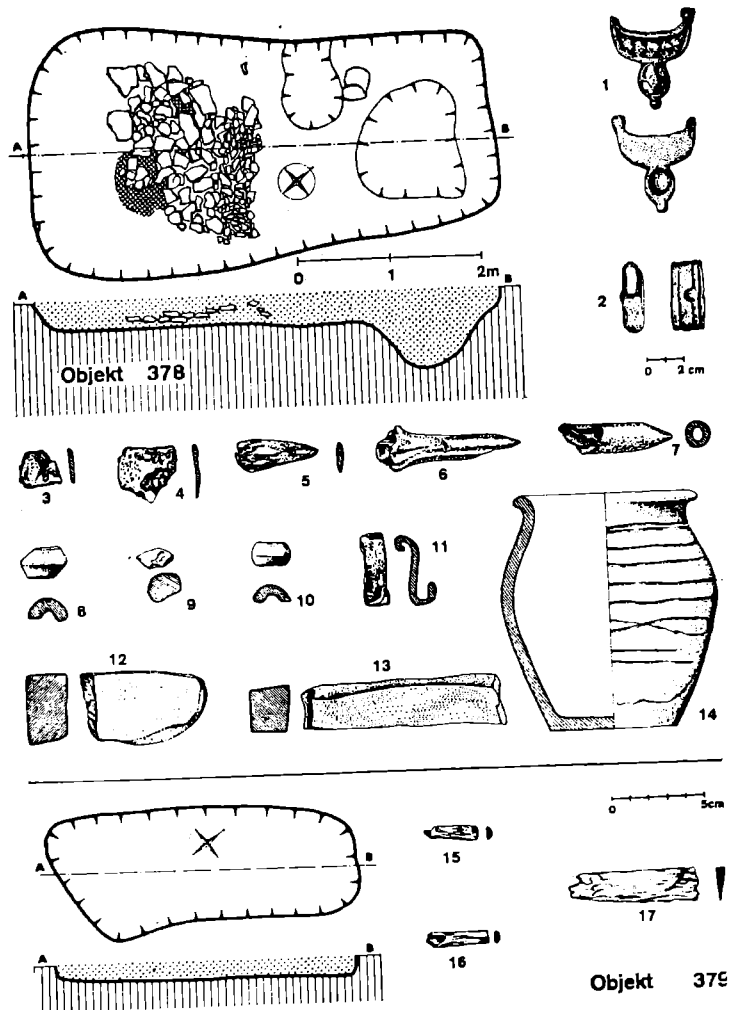

Tab. 139. Obj. 378: 4-169102/2, 5-169102/1, 6-169106, 7-169107, 8-169108/1, 9-169108/2, 10-169108/3, 11-169105, 12-169102/3, 13-169104, 14-169103, 15-169110, 16-169109, 17-168733; obj. 379: 18-169226/1, 19-169226/2, 20-168224.

Tab. 140. Obj. 381: 1-169451, 2-169452; obj. 382: 3-169658, 4-169657, 5-169659; obj. 383.

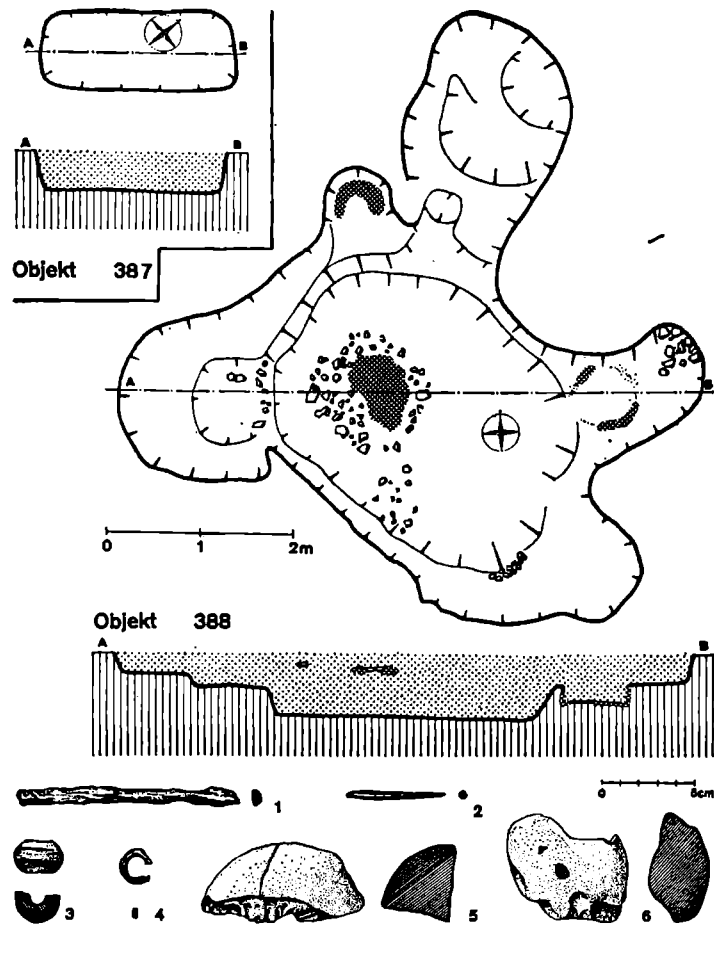
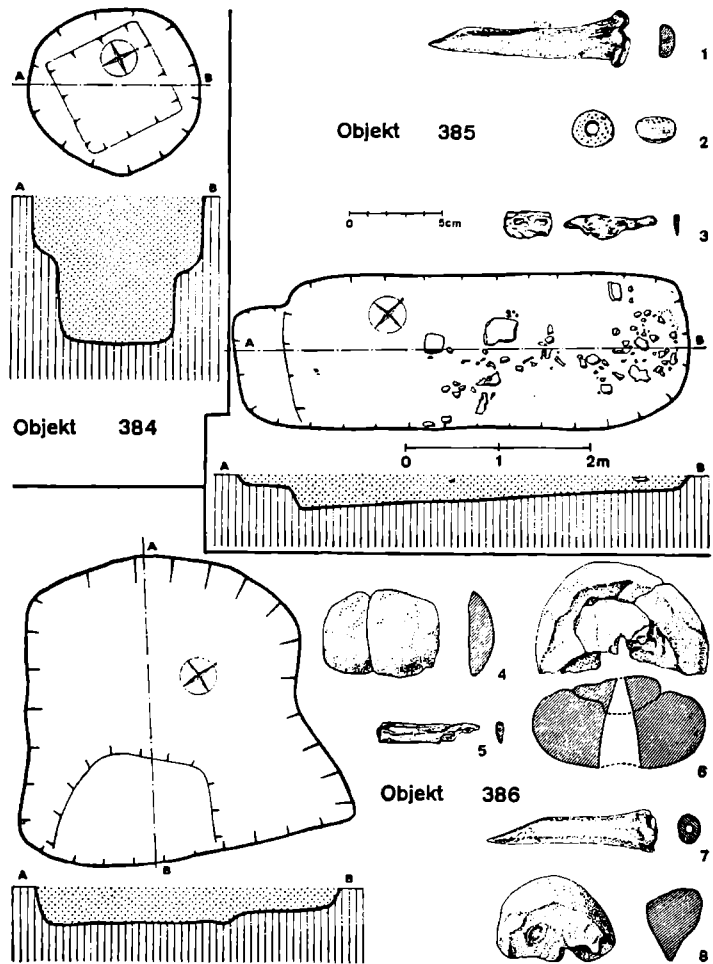

Tab. 141. Obj. 384; obj. 385: 1-169677, 2-169678, 3-169676; obj. 386: 4-169723/2, 5-169721, 6-169723/1, 7-169722, 8-169723/3,

Tab. 142. Obj. 387; obj. 388: 1-170900/1, 2-170903, 3-170915, 4-170902, 5-170916/1, 6-170916/2.

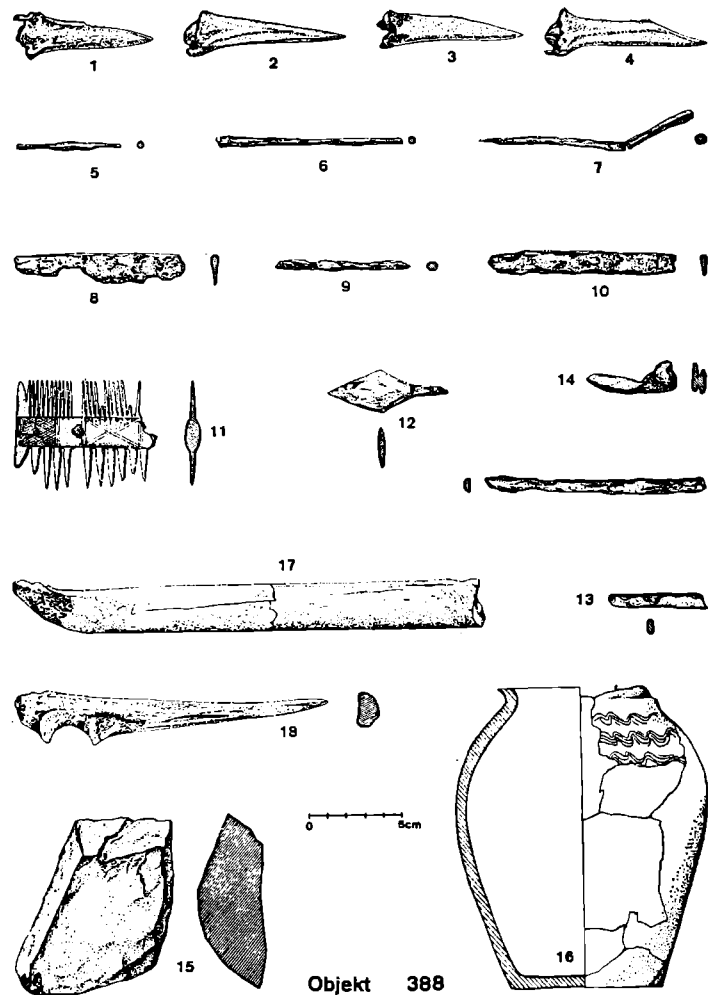

Objekt 388

Tab. 143. Obj. 383: 1-170908, 2-170910, 3-170909, 4-170912, 5-170901/2, 6-170907, 7-170901/1, 8-170905, 9-170898, 10-17 9, 6, 11-170913, 12-170904, 13-170900/2, 14-170899, 15-170917, 16-170914, 17-170914, 18-170911.

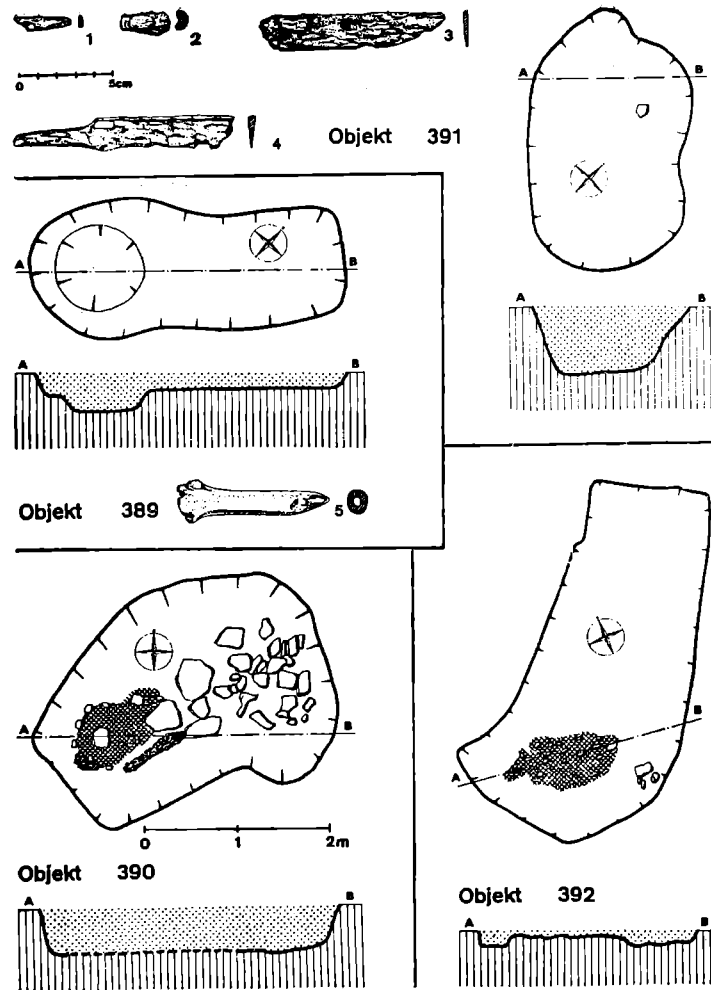

Objekt 389

Objekt 390

Objekt 391

Objekt 392

Tab. 144. Obj. 389: 5-170995; obj. 390: obj. 391: 1-171054, 2-171055, 3-171053, 4-171052; obj. 392.

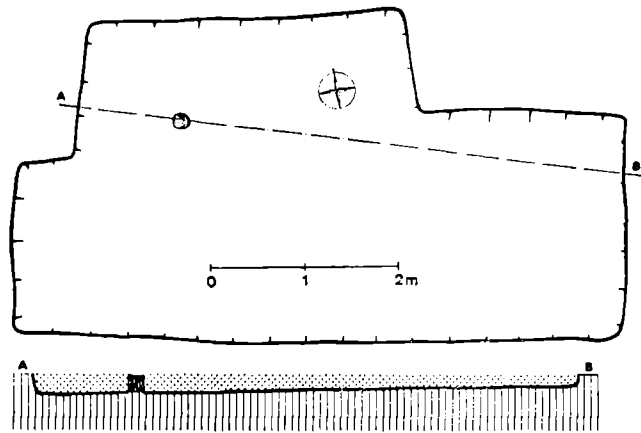

Objekt 393

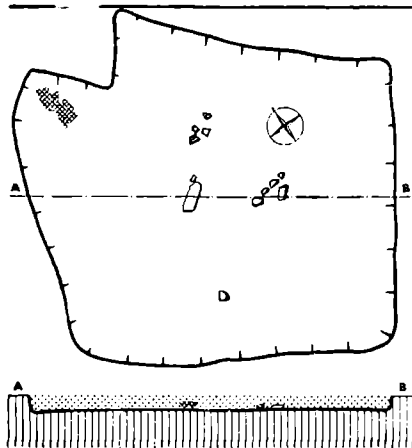

Objekt 394

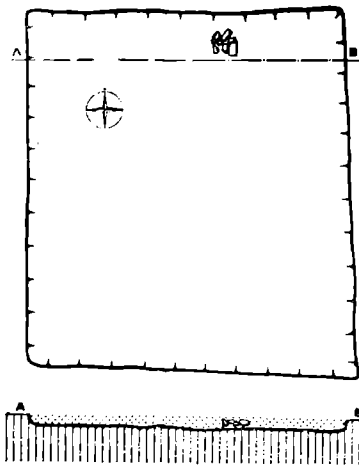

Objekt 395

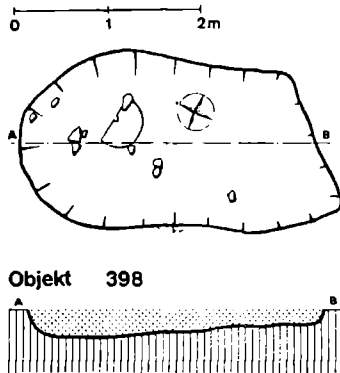

Objekt 398

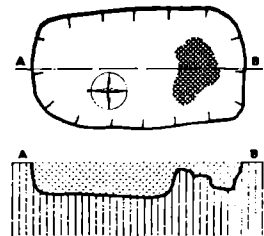

Objekt 396

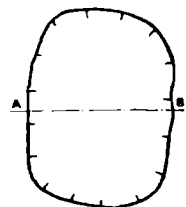

Objekt 397

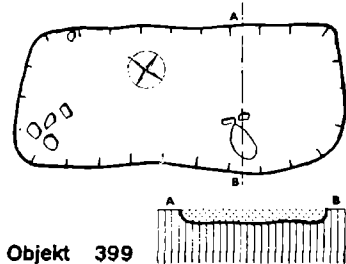

Objekt 399

Objekt 400

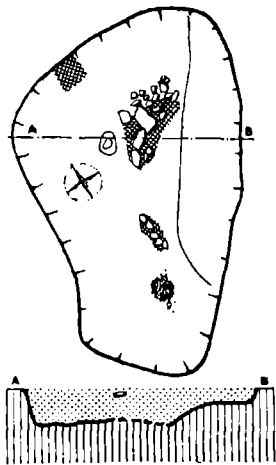

Objekt 409

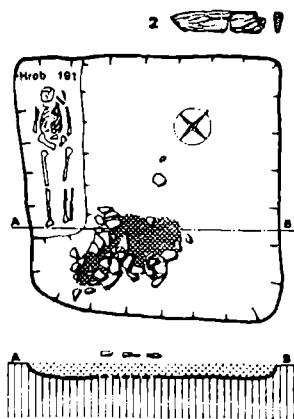

Objekt 401

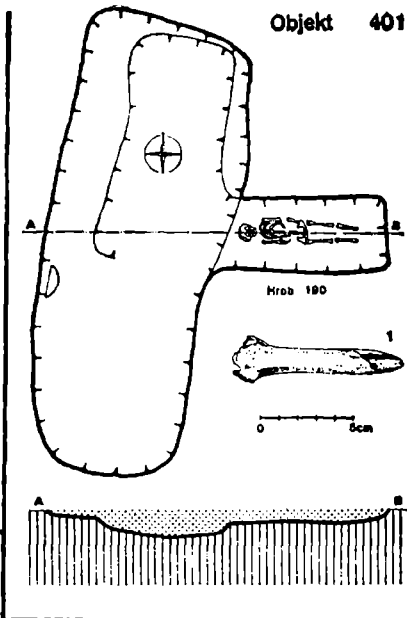

Objekt 402

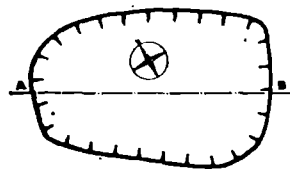
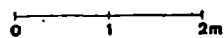
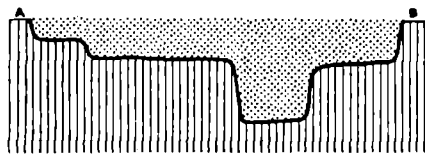

Objekt 403

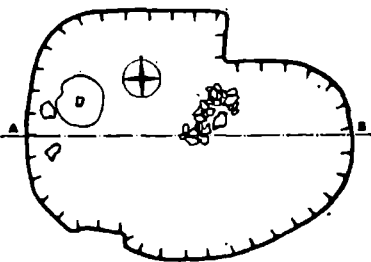

Objekt 404



Objekt 405



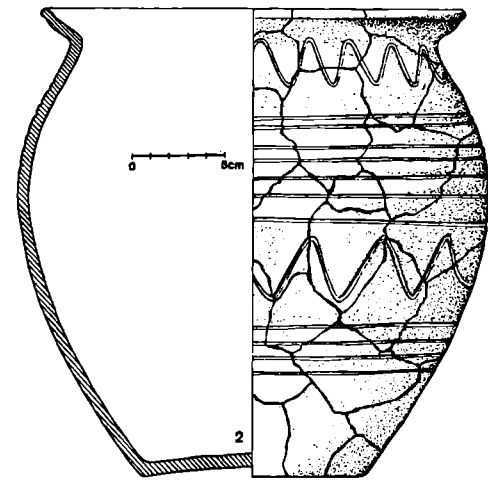
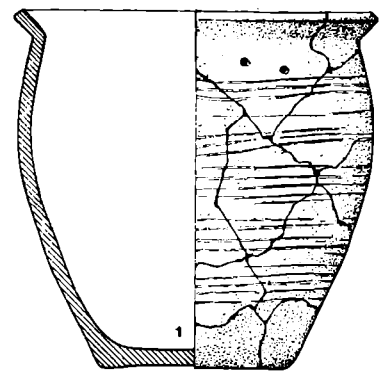
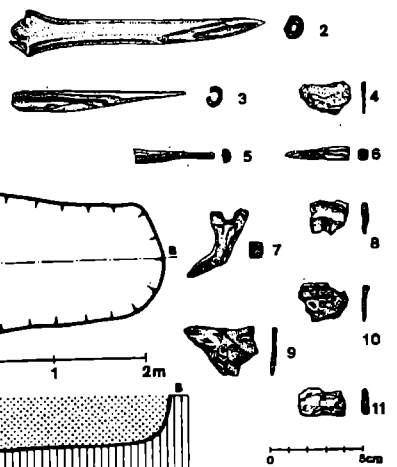
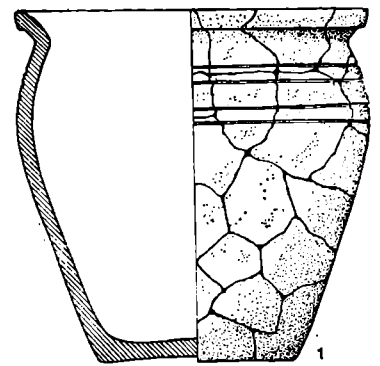
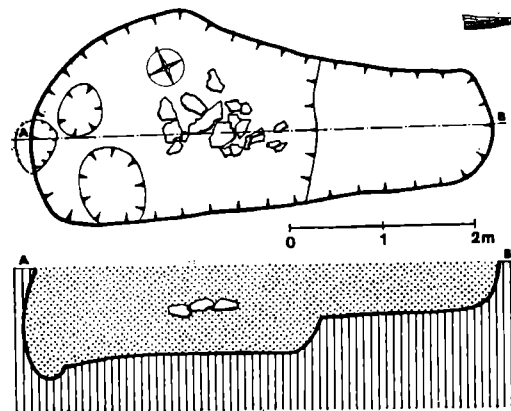
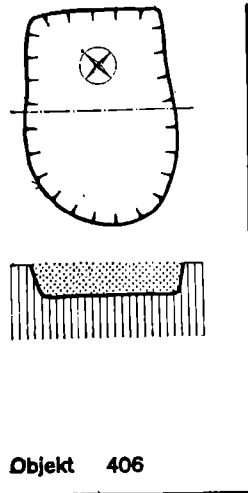

Tab. 149. Obj. 406; obj. 407: 1-171481, 2-171804, 3-171805, 4-171800/2, 5-171801, 6-171798, 7-171797, 8-171803, 9-171800/1, 10-171802, 11-171799.

Tab. 150. Obj. 407: 1-171482, 2-171480.

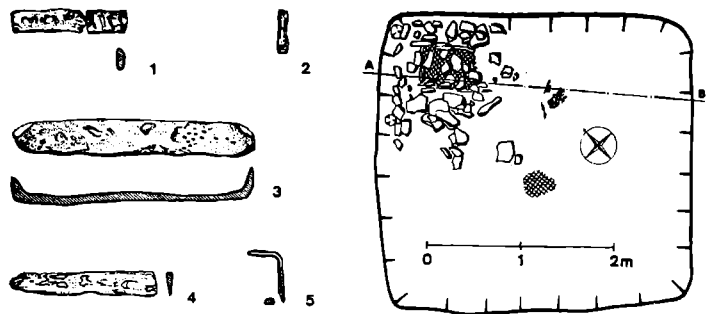

Objekt 411

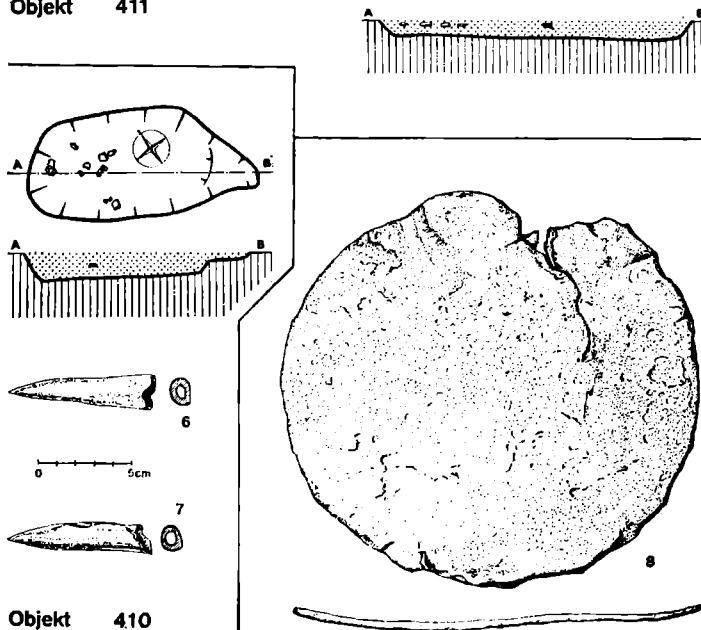

Objekt 410

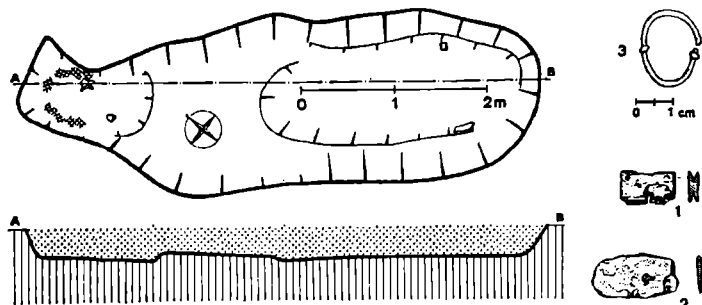

Objekt 412

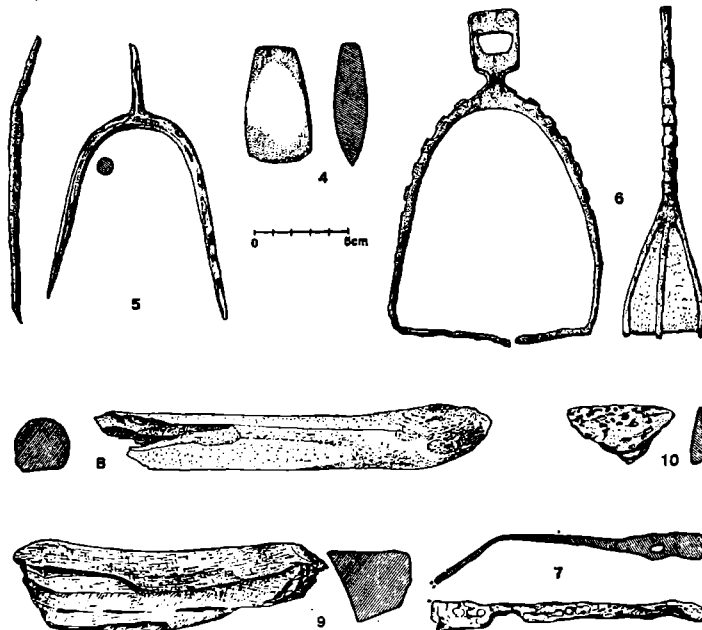

Tab. 151. Obj. 410: 6—172005, 7—172006; obj. 411: 1—172041, 2—172042, 3—172038, 4—172040, 5—172039; ctv. N 25—3: 8—159202

Tab. 152. Obj. 412: 1—172322, 2—172325/1, 3—172325, 4—172329, 5—172324, 6—172326, 7—172325/2, 8—172328, 9—172330, 10—172323.

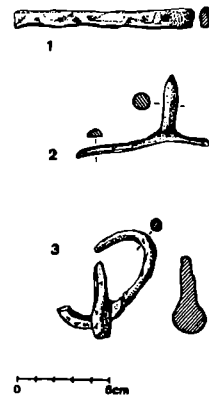
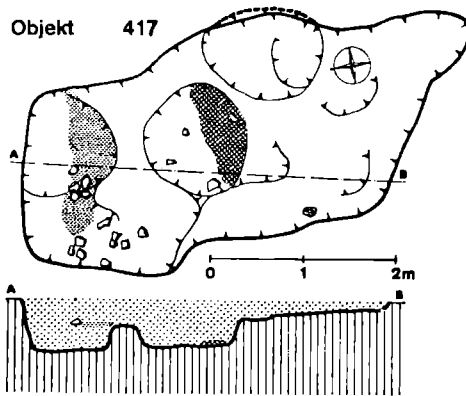
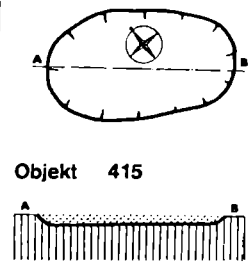
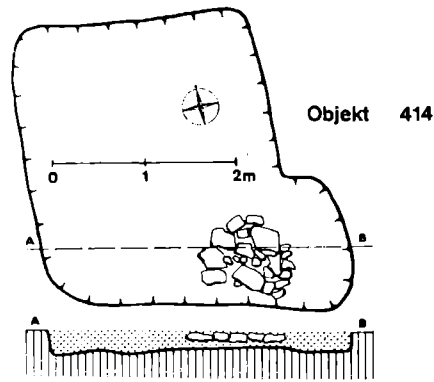
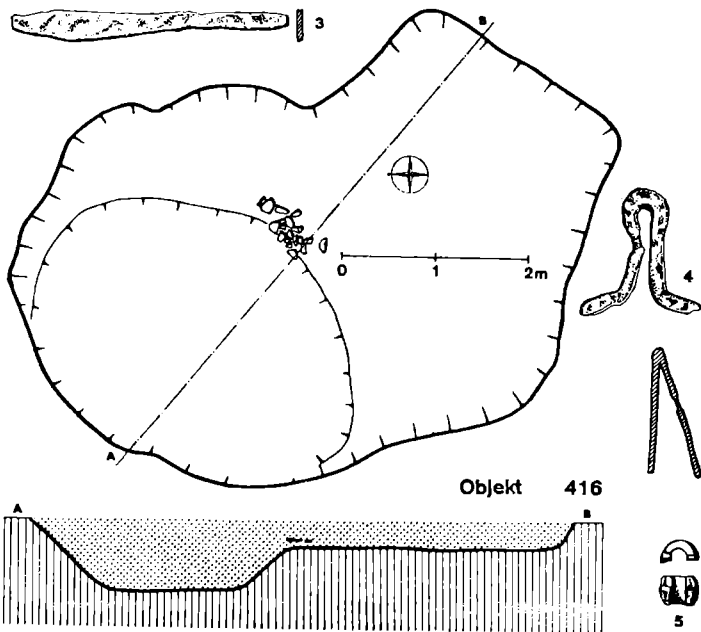
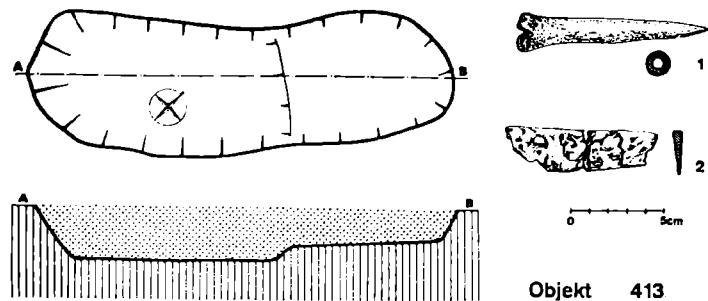

Tab. 153. Obj. 413: 1-172459, 2-172458; obj. 416: 3-172627, 4-172626, 5-172628.

Tab. 154. Obj. 414; obj. 415; obj. 417: 1-172822, 2-172821, 3-172827, 4-172824, 5-172823, 6-172826/1, 7-172826/2, 8-172826, 9-172825.

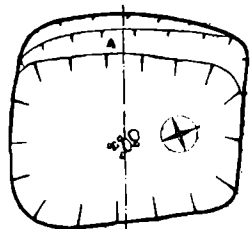
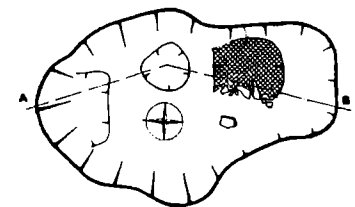
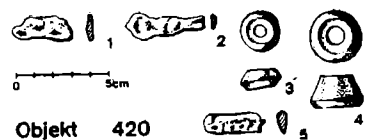

Objekt 419

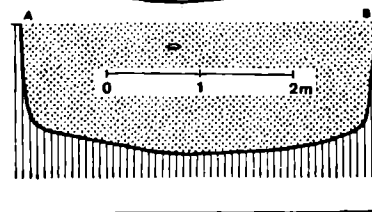
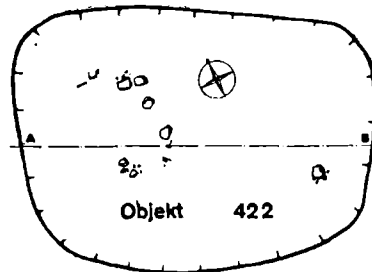

Objekt 422

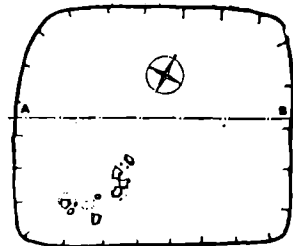

Objekt 423

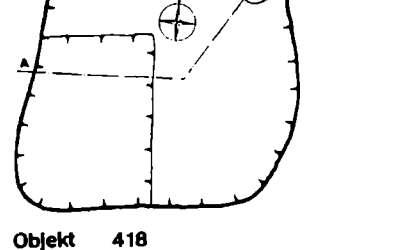
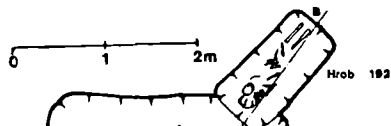

Objekt 418

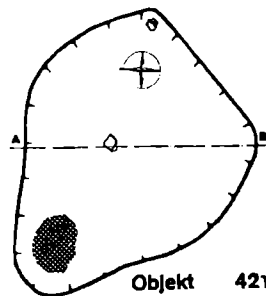

Objekt 421

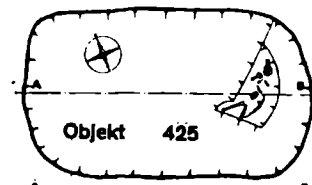
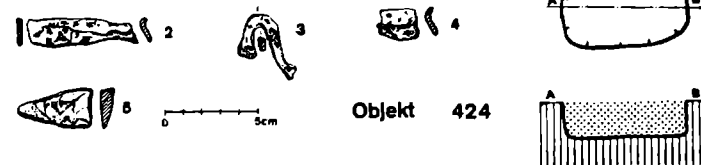

Objekt 425

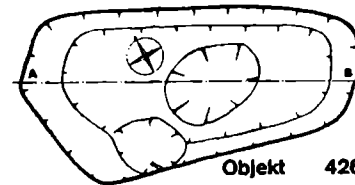

Objekt 426

Tab. 155. Obj. 418; obj. 419; obj. 420: 1-172981/1, 2-172981/2, 3-172983, 4-172982, 5-172981/3; obj. 421.

Tab. 156. Obj. 422; obj. 423: 1-173044; obj. 424: 2-173067, 3-173065, 4-173068, 5-173066; obj. 425; obj. 426.

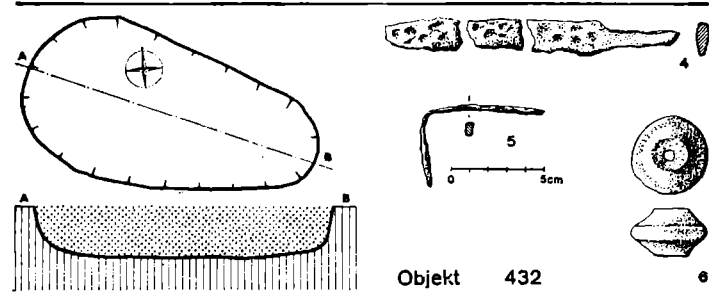
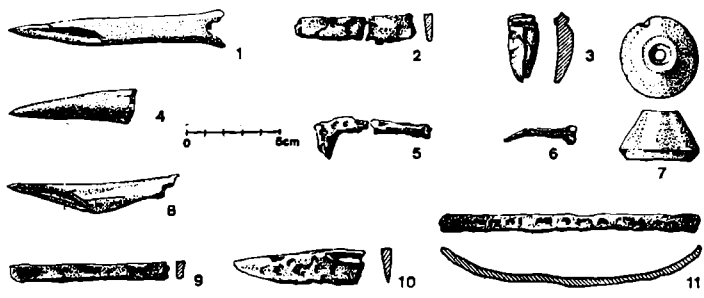
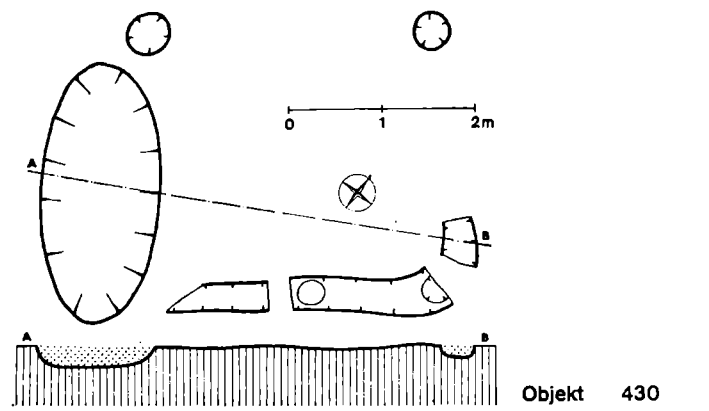
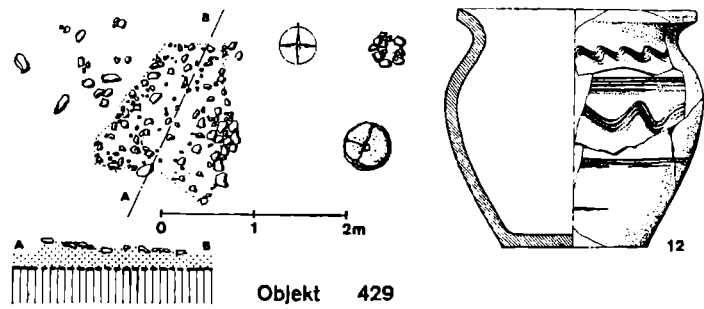
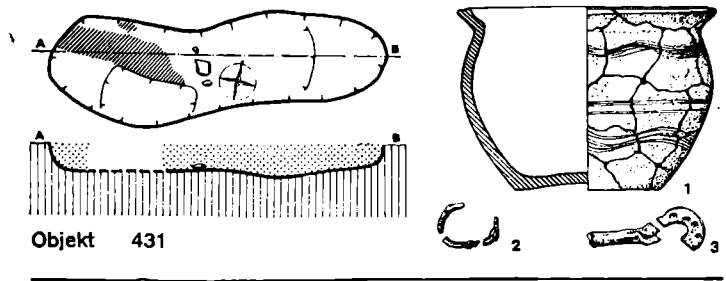
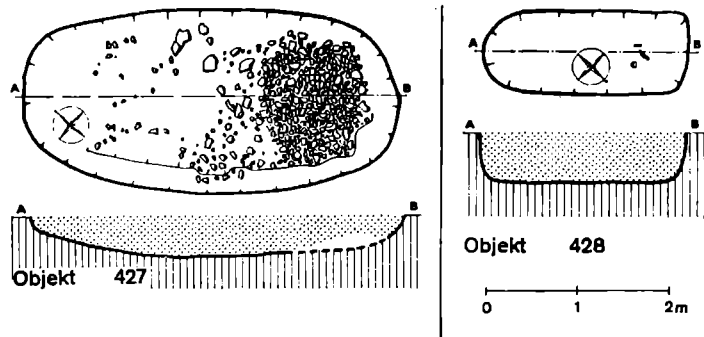

Tab. 157. Obj. 427; obj. 428; obj. 429: 1-174241, 2-174235/2-3, 3-174234, 4-174240, 5-174239, 6-174236, 7-174243, 8-174242, 9-174238, 10-174235/1, 11-174237, 12-173511.

Tab. 158. Obj. 430; obj. 431: 1-174425, 2-174406, 3-174405; obj. 432: 4-174457, 5-174458, 6-174459.

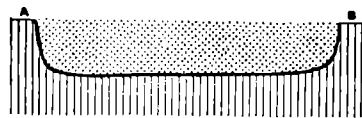
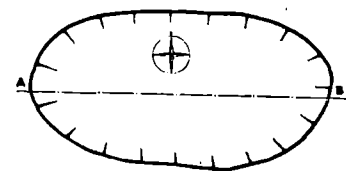

Objekt 433

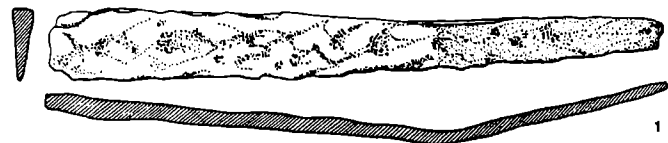

1

0 1 2m

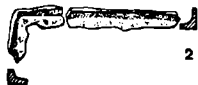

2



3



4

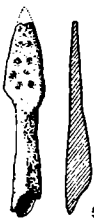

5

0 5cm

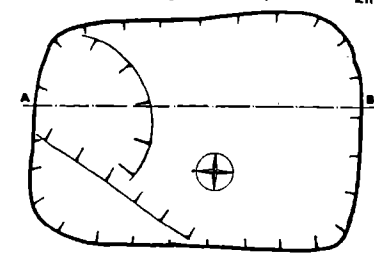

Objekt 434

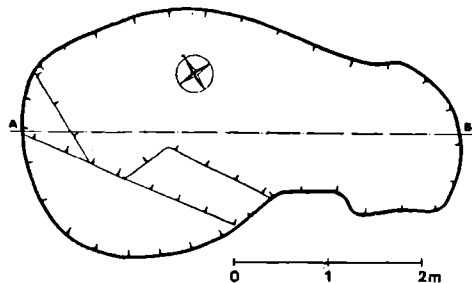

0 1 2m



1



2



3

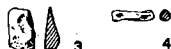

4

0 5cm

Objekt 435

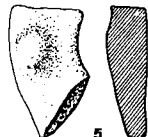

5

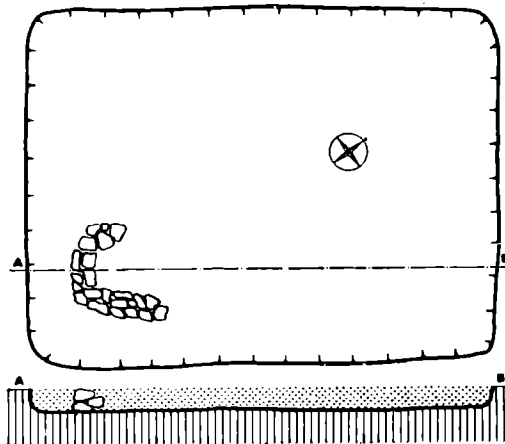

Objekt 436

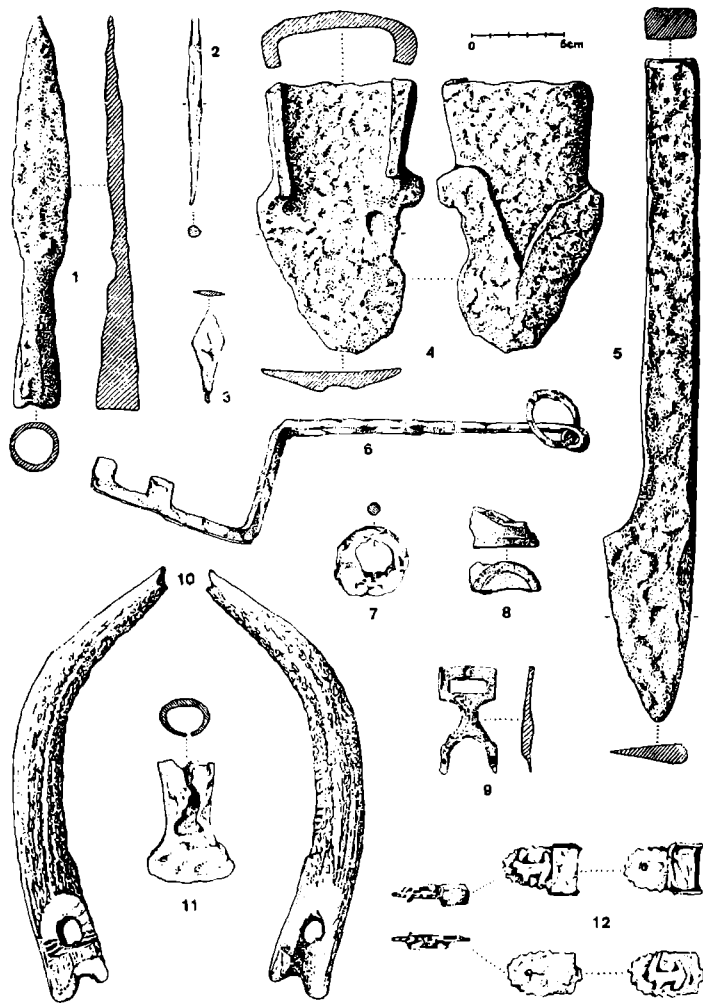

Tab. 161. Nález z vrstvy: 1-159207, 2-127478, 3-144203, 4-165061, 5-159205, 6-144504, 7-144211, 8-159198, 9-159060, 10-00000, 11-127477, 12-144123/1-2.

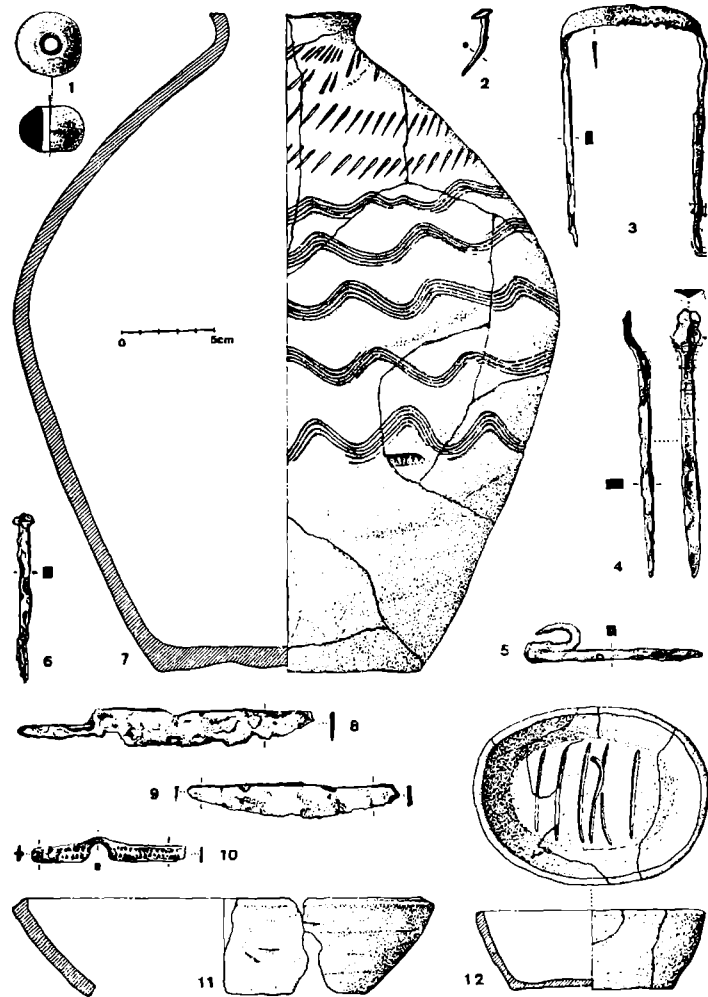

Tab. 162. Nález z vrstvy: 1-40223, 2-neinv., 3-40195, 4-40106, 5-39858, 6-40050, 7-40017, 8-39857, 9-39856, 10-neinv., 11-157220, 12-neinv.

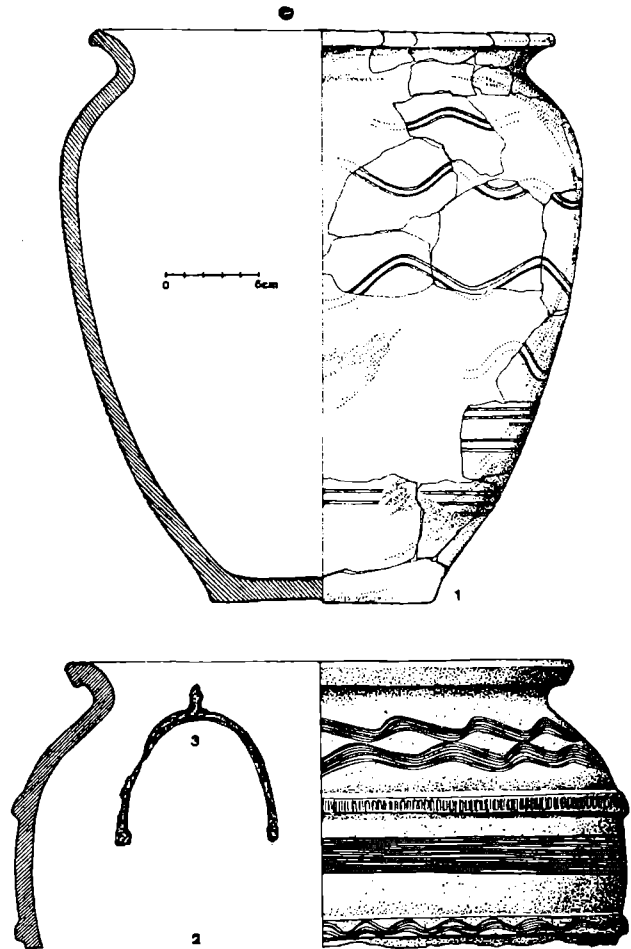

Tab. 103. Nálezy z vrstvy: 1-144505, 2-40053, 3-40049.